

DRY-DOCKING

1. SCOPE

1.1 Intent. This Standard Specification describes the requirements for the Contractor to dock and undock Coast Guard surface assets.

1.2 Appendices. The following appendices apply to this standard specification.

PROCESS STANDARD	APPENDIX
Requirement for Calculations	A
Requirements for Facility Inspection	B
Requirements for Docking and Lifting Cradles	C
Not Used	D
Conference and Inspection Checklists	E

1.3 Acronyms and term definitions. Below are definitions of various acronyms and terms that are used in this standard or may be encountered in work item specifications.

- **Drydock:** When used generically in this specification, this term refers to all means of removing a vessel from the water, including Graving Docks, Floating Drydocks, Marine Railways, Vertical Shiplifts (e.g. Syncrolift™) and crane (e.g. Travel Lift™).
- **GM:** Transverse Metacentric height (stability index).
- **Haul out:** A haul out is defined as lifting or hoisting of a vessel, where arrival condition is either afloat or in a cradle on a trailer, using a heavy lift rigging configuration with a crane, derrick, or gantry type crane (e.g. Travel Lift).
- **Facility:** Refers to a specific dry dock operated by Contractor with unique identity (designator, model number, etc.)
- **Fleet/Fleeting:** The action of refloating and shifting of a vessel to an alternate docking position to facilitate 100% preservation of the vessel's underwater body, or other necessary work.
- **KG:** Vertical Center of Gravity (VCG) above the baseline (keel).
- **KM:** Transverse Metacentric height above the baseline (keel).
- **LOA:** Length over all.
- **Soft cap:** Forms the top of the keel or side/bilge block, usually; has lower permissible compressive stress and proportional limit than other materials used in block construction.

2. REFERENCES

COAST GUARD DRAWINGS

Coast Guard Drawing 87 WPB 085-012, Rev A, 87 Ft Lifting Cradle and Docking Plan
Coast Guard Drawing 87 WPB 085-013, Rev B, Docking Plan
Coast Guard Drawing 110 WPB 085-002, Rev 1, Docking Plan, A Class
Coast Guard Drawing 110B WPB 085-002, Rev B, Docking Plan, B Class
Coast Guard Drawing 110C WPB 085-002, Rev A, Docking Plan, C Class
Coast Guard Drawing 110 WPB 085-010, Rev C, Docking Plan, Docking/Lifting Cradle ('A', 'B', & 'C' Classes)

COAST GUARD PUBLICATIONS

Surface Forces Logistics Center Standard Specification 0000 (SFLC Std Spec 0000), Latest Revision, General Requirements
Surface Forces Logistics Center Standard Specification 0740 (SFLC Std Spec 0740), Latest Revision, Welding and Allied Processes

OTHER REFERENCES

American Bureau of Shipping (ABS), Rules for Survey after Construction, 2017, Part 7, Chapter 10, Steel Floating Dry docks
American Bureau of Shipping (ABS), Rules for Building and Classing Steel Floating Dry Docks, 2009
Code of Federal Regulations (CFR) Title 29, Part 1917.50, July 2017, Marine Terminals, July 2017
Code of Federal Regulations (CFR) Title 29, Part 1919, July 2017, Gear Certification
Code for Lifting Appliances in a Marine Environment, Lloyd's Register 2017
The Society for Protective Coatings (SSPC)/NACE International (NACE) Joint Surface Preparation Standard SSPC-SP WJ-4/NACE WJ-4, 2012, Waterjet Cleaning of Metals – Light Cleaning.
Rules and Regulations for the Construction and Classification of Floating Docks, Lloyd's Register 2017
MIL-STD-1625, 2009, Safety Certification Program for Dry-docking Facilities and Shipbuilding Ways for U.S. Navy Ships

3. REQUIREMENTS

3.1 General. The Contractor shall maintain facility certification and subsequently meet the requirements to dock/undock a designated Coast Guard surface asset as specified in this standard and in accordance with requirements specified in SFLC Std Spec 0000.

3.2 Requirement for certification. The Contractor's dry dock shall first be certified by a Coast Guard-approved method as specified in this standard.

NOTE

The certification methods, calculations and related items listed throughout this specification ensure that the contracted dry dock has sufficient lifting capacity and structural strength for safely handling a Coast Guard vessel within the trim and stability requirements for dry-docking. This certification also serves as verification that the Contractor shall maintain compliance with the industrial standards for safety.

3.2.1 Submittal of dry dock certification. The Contractor shall submit documentation of their facility’s dry dock certification to the KO for approval. Coast Guard approval is based on COR review and KO acceptance of the submitted certification.

3.2.2 Drydock certification. The Contractor shall be aware that the criteria for their dry dock capability shall be based on an independent inspection and certification, see Appendix B for details of inspection criteria. Each dry dock facility the Contractor possesses shall be certified individually.

3.2.3 Drydock certification method. Proof of structural and operational integrity of a Contractor’s dry dock facility and certification shall be achieved by one of the following methods:

TABLE 1 - DRYDOCK CERTIFICATION METHOD

CERTIFICATION TYPE	ACCEPTABLE STANDARD/ DOCUMENTATION	TYPE OF DRYDOCK FACILITY APPLICABILITY					
		FLOATING	GRAVING	MARINE RAILWAY	VERTICAL LIFT	CRANE/ TRAVEL LIFT	DOCKING/ LIFTING CRADLE
NAVSEA (See 3.2.3.1.2)	MIL-STD-1625 (Sections 1.2.4 and 4.10.5 do not apply)	•	•	•	•	•	•
Professional Engineer (See 3.2.3.1.3)	Independent Professional Engineer inspection survey of the dry dock condition that is signed and sealed	•	•	•	•	•	•
Lloyd’s Register (See 3.2.3.1.4)	Rules and Regulations for the Construction and Classification of Floating Docks. Code for Lifting Gear in a Marine Environment; Chapter 3, 4, 6, 9 and 10	•		•	•	•	
American Bureau of Shipping (ABS) (See 3.2.3.1.5)	Rules for Survey After Construction	•					
OSHA (See 3.2.3.1.6)	29 CFR Part 1917 and Part 1919					•	

3.2.3.1 Required documentation.

3.2.3.1.1 Certification inclusions. Regardless of the type of certification provided, the Contractor shall submit to the KO the following information regarding the docking facility. This information shall accompany the required certification documents but is not required to be part of the formal certification; the information may be taken from the contractor's standard operating procedures, drawings, or other documents.

- Fire alarm locations.
- Emergency power plan.
- Emergency ballast/dewatering pumping plan showing pump locations, applicable to floating dry docks and graving docks only.

3.2.3.1.2 Required Documentation for NAVSEA Certification. The Contractor shall provide the NAVSEA certificate showing certified capacity and dock ratings, the NAVSEA certification letter, and any status updates for scheduled maintenance items required by the certification.

3.2.3.1.3 Required Documentation for Professional Engineer Certification. The Contractor shall provide the certification form and inspection checklists that are found in Appendix B. Each certification shall include the checklist signature cover page; the checklist for all facilities types (see Appendix B3-B5), and the checklist specific to the type of facility certified (See appendix B6-B24 – as required.) The foundation checklist (see Appendix B-25) shall be included for all facilities where the final blocking location is not an integral part of the dry dock (required for crane and travel lift facilities).

3.2.3.1.4 Required Documentation for Lloyds Register Certification: The Contractor shall provide documentation of the most recent Lloyds Register periodical facility surveys including annual, underwater and 5 year special survey and documentation from surveyor or original drawings indicating the certified capacity and load ratings as approved and certified by Lloyds Register.

3.2.3.1.5 Required Documentation for ABS Certification. The Contractor shall provide documentation of the most recent ABS classed vessel condition survey and documentation from surveyor or original drawings indicating the certified capacity and load ratings as approved and certified by ABS.

3.2.3.1.6 Required Documentation for OSHA Certification. The Contractor shall provide the most recent annual certification from OSHA (Form 71), most recent quadrennial or quinquennial survey with proof weight test results, and any supplemental findings of deficient items as reported to OSHA (Form 72). Since the OSHA inspections/certification is limited to the lifting equipment, a Professional Engineer's certification is also required for the pier structure and blocking foundation portions of the facility (see 3.2.3.1.3).

3.2.3.1.7 Block/Cradle Foundation Certification. If the final docking location of the vessel on blocks/cradle is not on the dock floor of a certified graving dock, floating dry dock, marine railway, or vertical lift, the block/cradle foundation site shall be certified separately by a Professional Engineer (see 3.2.3.2 Clarification for dry dock certification methods). Facilities using a crane or travel lift, with or without a lifting cradle, shall also include a certification of the final block/cradle foundation site. Permanent transfer tracks, built and used exclusively with a dry dock facility, may be certified along with the facility they service, no separate certification is required.

3.2.3.2 Clarification for dry dock certification methods. The Contractor shall be aware that certification methods listed above are explained as follows:

3.2.3.2.1 Inspection survey. The inspection survey checklists for all types of dry docks and block/cradle foundations are defined in Appendix B (Requirements for Facility Inspection). The format of the inspection checklists, provided in Appendix B, shall be used in validation of certification by an independent Professional Engineer.

3.2.3.2.2 Drydock certification period. Coast Guard approval of the submitted certification shall remain in effect as long as the certification is current and contractor is in compliance with the certifying agency's requirements. In the case of an independent Professional Engineer's inspection survey, the period of certification is defined in Appendix B.

3.2.3.2.3 Validation of operational test. Each method of certification shall include an operational test of the facility. If an operational test requirement is specified by the certification method (NAVSEA, ABS, OSHA, etc...) those methods shall be followed. If no other operational test requirements are specified (PE certification) the following guidance shall be followed. For a valid operational test for cranes and travel lifts, the lifting equipment shall be tested to a minimum of 125% of the weight of the vessel to be dry docked. For cranes, this test should be completed at a lift radius and angle suitable for docking the intended USCG asset. For floating docks, graving docks, vertical lifts, and marine railway facilities the operational test should be completed with an appropriately sized vessel (or other weight) to show all aspects of the facility are operational. The details and results of the load test should be reflected in the facility certification.

3.2.3.2.4 Cradle construction and test. The Contractor shall be aware that requirements for the construction and operational testing of docking and lifting cradles are defined in Appendix C (Requirements for Docking and Lifting Cradles).

3.2.3.2.5 Cradle inspection. In the presence of the certifying agency, the Contractor shall perform Non-Destructive Examination (NDE) of the cradle/spreader bar weld joints designated by the certifying agency in accordance with SFLC Std Spec 0740, Appendix C for each certification inspection cycle (see B2.3.1 (Cycle for cradle certification)). The certifying agent shall provide a signed/sealed written test report for the completed NDE test to the Contractor for submittal to the KO for approval.

3.2.3.2.6 Modification of a certified dry dock. The Contractor shall report any changes, modifications or major repairs made to their dry dock structure/facility to the certification agency as well as to the KO. The certification shall be revised to document the structural/facility modification and resubmitted to KO for approval. The certification revision shall be approved prior to docking any USCG asset.

3.3 Docking personnel. The Contractor shall provide qualified docking personnel including a qualified Dockmaster.

3.3.1 Dockmaster. The Contractor shall provide written certification for the Dockmaster and include a resume stating training and experience that meets one of the following criteria:

- Has served as a Dockmaster at the type of facility for which the individual is qualified during at least 10 docking/undocking evolutions, of which one has been accomplished within the previous 6 months.
- Has served under a Dockmaster, in an apprentice or assistant role during at least 20 docking/undocking evolutions, of which 10 have been performed at the type of facility for which the individual is qualified with one docking/undocking evolution conducted within the previous 6 months.
- Has served under a Dockmaster in an apprentice or assistant role during at least 10 docking/undocking evolutions and has served as a Dockmaster at the type of facility for

which the individual is qualified during at least 5 docking/undocking evolutions, of which one has been accomplished within the previous 6 months.

3.3.2 Manning personnel. The Contractor personnel stationed for the dry-docking evolution shall be experienced in dry-docking operations and equipped with appropriate tools and communication devices throughout the dock/undock evolution.

3.4 Safety.

3.4.1 All dry-dockings of cutters and boats shall require safety measures in accordance with this Standard Specification and its referenced documents.

3.4.2 While docked there shall be no shifting of weights, fuel, fresh water or ballast without the express permission of the Dockmaster.

3.5 Drydocking events.

3.5.1 Pre-award events.

3.5.1.1 Documentation Submittal. If certification is not currently on file with Coast Guard, the Contractor shall submit their dry dock certification (see 3.2.1 (Submittal of dry dock certification)) at the time of pre-award to the KO for approval. The contractor shall also submit written certification and resume of Dockmaster (see 3.3 (Docking personnel)).

3.5.1.2 Pre-award calculations. The Contractor shall provide to the KO a set of pre-award calculations, as described in Appendix A. As applicable, the contractor shall also submit an alternate blocking arrangement with the pre-award calculations which consists of any changes from the CG docking plan provided in the work package.

3.5.1.2.1 Vessel information. The KO will provide the Contractor with docking plan information/ drawings, hydrostatic information and specific vessel Principle Characteristics in the work package from the KO. For additional information necessary to perform dry dock calculations submit a request to the KO.

3.5.1.2.2 Validation of dock capacity. For validation of the Contractor's dry dock maximum rated capacity as stated in the submitted certification. In relation to the specific vessel's displacement that is to be dry docked, the Contractor's dry dock capacity shall be a minimum of 125% of the weight of the vessel as provided (see 3.5.1.2.1 (Vessel information)). In a case where the dry dock maximum rated capacity does not meet the validation requirement the Contractor's pre-award calculations shall include liquid and dead loading instructions, with resultant VCG, TCG, LCG and GM values, for the specific vessel. The Contractor shall demonstrate the dry-docking can safely be accomplished. This shall be considered a unique Contractor requirement to dock the vessel and shall be approved by the KO.

3.5.1.2.3 Review of Contractor's requirement. The Contractor shall provide the KO their unique requirements for the vessel's loading or blocking at pre-award for review and approval. The KO shall provide the Contractor the results of the review prior to contract award. If an alternate blocking plan is required, the specific details of that plan, including the vertical block offsets and positioning, shall be provided for every block that does not fall in a location defined by the USCG standard docking plan.

3.5.2 Pre-Docking events.

3.5.2.1 Vessel arrival load conditions. The Contractor will be provided with the vessel's estimated arrival loading conditions by the COR no later than seven days before the docking day. If the vessel's estimated trim or list requires a reduction, the Contractor shall coordinate with the COR to accomplish the following:

3.5.2.1.1 Trim considerations. The Contractor shall work with the COR and vessel's CO/OIC to obtain minimal trim of the vessel being docked. The trim condition must account for any design drag; which occurs when the vessel's keel is designed to not be parallel to the design baseline. When it is necessary or desirable to dock a vessel with appreciable trim, both the point load on the knuckle block and the maximum unit stress at the after end of the knuckle block must remain within permissible limits of the timber, as shown in Appendix A.

3.5.2.1.2 List considerations. The Contractor shall work with the COR and vessel's CO to ensure that all list as practicable, shall be eliminated from the vessel being docked before attempting to dry dock (list angle shall be 0 degrees),.

NOTE

If examination of the vessel by the Contractor's Dockmaster is not possible before docking, the COR/CO will inform the Contractor of the amount of list, and its probable cause. This information shall be furnished sufficiently in advance of the time of dry-docking to permit safe docking arrangements to be made without delay.

3.5.2.2 Block construction. The Contractor shall arrange blocks, as shown on the USCG docking plan for the vessel class, ensuring the following:

- The Contractor shall establish a benchmark for centerline and baseline. The dock floor shall not be considered a baseline unless it can be proven flat, without slope, peaks or depressions
- The dimensional tolerances for the vessel's docking plan shall be the following:
- The height of the vessel's blocks are within ¼”.
- The distances in the longitudinal direction are within 1”.
- The distances of the half breadths (transverse) for side/bilge blocks are within ½”.
- Soft caps shall be made of Douglas Fir or Pine. Keel block soft caps shall measure 2 inches minimum to 6 inches maximum in thickness. Side block soft caps shall measure 2 inches minimum to 6 inches maximum in thickness at their shortest (inboard) corner. Side blocks have no maximum thickness limitation at their longest (outboard) corners. Keel block soft caps shall not be thicker than the shortest corner of the side blocks. Reused soft caps shall be free from any permanent deformations, i.e. crushing, cracking or other material defects.
- The line of normal force for all blocking shall pass through the middle one-third of the block base as shown in Figure 1 (Side/Bilge Block Construction).
- Docking blocks shall be made of homogeneous materials. Keel blocks shall be fabricated of the same materials. Side/bilge blocks shall all be fabricated of uniform structure and materials. The side/bilge blocks shall not be of stiffer construction material than the keel blocks. Block material below the soft cap shall be constructed of one of the following materials: concrete, hard wood or steel.
- Blocks shall be secured to prevent wood from floating out of position during the docking/undocking evolution
- Bilge blocks higher than six feet, as measured from the bottom of the block to the highest point of the soft cap, shall be stiffened both front and back sides from top to bottom to

prevent buckling and tied together in pairs by means of cribbing or bracing. If the side blocks are hauled into position during the docking evolution while tied together, then they shall be hauled simultaneously. When stiffening high bilge blocks or bracing two blocks together, the minimum acceptable bracing material shall be four (2"x6") wooden planks in a normal-to-hull pattern or a cross-braced pattern and lag bolted in place, shown in Figure 2 (Stiffened or Braced Bilge Blocks). Keel blocks higher than six feet shall be cribbed together in the both forward and after one third of the keel block line. The cribbing shall be a minimum of 12-inch thick when used with timber blocks.

- While constructing blocks, according to the docking plan provided in the work package, the Contractor shall ensure that no obstructions exist between the dry dock surface and hull openings or fittings. The Contractor shall also ensure horizontal and vertical clearance to remove and replace appendages, including but not limited to rudders, shafts, fin stabilizers, transducers, sonar domes, and retractable bow thrusters, as applicable. This clearance shall be considered whether or not removals are specified in the work package.
- Blocks constructed for vessel dockings/haul outs, shall be placed on a permanent solid foundation such as concrete, concrete aggregate, dock floors, or cradle fixtures. Cradle fixtures used for vessel haul outs shall be placed on a permanent solid foundation. No block or cradle shall rest on loose soil, gravel, sand or other non-permanent foundation. (See 3.2.3.1.7 (Block/Cradle foundation certification).)

CAUTION!

In cases where cradle fixtures are combined with additional blocks, both shall be placed on a permanent solid foundation of uniform composition.

NOTE

The position of the vessel on the blocks, as found in the docking plan drawing, will be specified in the work item provided in the work package. Sequential positioning (1, 2, etc) allows for paint schedules to cover the hull plate over multiple docking cycles.

3.5.2.3 Vessel arrival. The Contractor shall dock the vessel within 72 hours after the vessel has arrived at the Contractor's facility. Except in the case where a pre-docking shaft alignment check shall be performed. When a pre-docking shaft alignment is performed, ensure that the vessel is dry docked within 120 hours after arrival.

3.5.2.4 Three (3) business days before docking. Three (3) business days before docking the Contractor shall submit the docking calculations to the KO for review by the COR, as required in Appendix A. As applicable, the Contractor shall also submit an alternate docking block arrangement, which consists of any changes from the USCG docking plan provided in the work package. A Contractor's alternate docking plan/block arrangement shall be approved by the KO prior to docking a Coast Guard asset.

3.5.2.5 Twenty-four hours before docking. The Contractor shall convene the Pre-Docking Conference a minimum of 24 hours prior to docking. All of the following docking items shall be discussed to the satisfaction of the COR.

3.5.2.5.1 Docking checklists. The Contractor shall provide, upon request, information needed by the COR to complete the COR's Pre-docking Conference checklist, Pre-docking Dock Inspection, During & Post Docking Inspection, as well as the Pre-Undocking Conference Check List and Undocking Evolution Checklists. Checklists are provided in appendix E.

3.5.2.5.2 Block inspection. The Contractor shall not remove any instruments used to set block heights and verify block position until the COR has completed the block inspection. The Contractor shall establish a benchmark for centerline and baseline. The dock floor shall not be considered a baseline unless it can be proven flat, without slope, peaks or depressions. If a lifting cradle is used, that cradle shall be inspected on its final foundation. The cradle foundation shall not affect the final block height due to any induced twisting or bending from an unlevelled or uneven grade.

3.5.2.5.3 Manning for dry dock evolution. The Contractor shall provide to the COR a list of dry-docking procedure and operations that describes all stations to be manned and functions to be performed, including but not limited to, line handling, reference point sights over the build, draft readings, watertight integrity checks, casualty and damage control plans of action.

3.5.2.5.4 Drydocking procedure documentation. At the Pre-Docking Conference, the Contractor shall provide to the COR a written dry-docking procedure, which shall include the following:

- A short statement of operating procedure, safety requirements, and yard security plans.
- The flooding and pumping plan for a floating dry dock (guidance for preparation of a pumping plan is provided in Appendix A).
- Specific list and trim conditions of the vessel during docking.
- Any special precautions or actions required because of characteristics of the docking facility, the vessel, or a combination, e.g. tidal constraints, grade of dock railway.

3.5.3 Docking day events.

3.5.3.1 Docking evolution. The Contractor shall safely dry dock the vessel, during daylight hours, in one continuous evolution. Dry-docking outside of normal daylight hours shall be by special request approved by the KO. Requests for night dockings shall include documentation of adequate lighting and safety procedures and justification for the need. The dry dock is free of all debris and blasting material. As the first extremity of the vessel crosses the sill or plane of the dry dock, the point of the dry dock closest to the navigable channel, the Contractor's Dockmaster shall relieve the CO/OIC and take responsibility for the safety of the vessel.

3.5.3.2 Modification of loads. During the docking evolution, the Contractor shall ensure that no load has been shifted, added, or removed from the vessel, including liquids such as fuel or water, unless authorized by the Dockmaster. Submit a CFR for all liquid and dry load modifications during the docking evolution.

3.5.3.3 Personnel onboard vessel. During the docking evolution, the Contractor shall be aware of all personnel onboard, including both Coast Guard and civilian. The Contractor's Dockmaster shall have direct contact via radio with the personnel and shall provide them direction as necessary during the evolution. Personnel onboard during the docking shall be limited to minimal required for manning stations and their movement shall be limited as the vessel is positioned over and landed with full contact on the dock block build.

3.5.3.4 Assistance for safe docking of vessel. The Contractor shall provide all resources necessary to safely dry dock the vessel. Resources shall include but not be limited to, tugs and/or pusher boats, line handlers, and radio communications. The Contractor shall not use shipboard winches or any other deck machinery to control or winch the vessel into position, but may use appropriate attachment points on the vessel to secure and control the vessel during the docking/undocking evolution.

3.5.3.5 Weather delay. If the docking day is postponed for reasons of weather, including but not limited to excessive winds, freezing temperatures, heavy rains, the date shall be tentatively moved to the next

forecasted good weather day. The Contractor shall communicate with the COR and KO the reason for the delay and the anticipated rescheduled date for the event.

3.5.3.6 Floating dry dock operational limits. The Contractor shall operate a floating dry dock with the following limitations (see Appendix A for pumping plan and calculation requirements):

- Trim between the blocks and keel shall not exceed 1 foot per 100 feet of length during the landing of the vessel. Once the vessel is fully landed, a maximum ship/dock trim of 4 feet per 100 feet of length shall not be exceeded at any time. The dock may be trimmed to match the vessel's trim but shall not exceed the aforementioned limits.
- A minimum of 12 inches shall be maintained between the dry dock and the harbor bottom at all times.
- The final lifted pontoon deck freeboard shall be no less than 12 inches.

3.5.3.7 Divers. The Contractor shall use qualified divers to monitor block clearances during the positioning of the vessel over the blocks.

3.5.3.7.1 Divers are required for the following instances:

- When the distance between the hull and the blocks is expected to be nine inches or less.
- When hauling bilge blocks and to verify the success of hauling operations.
- When cradles are used for docking.
- When alternate blocking plans are used and a diver is determined to be necessary by the Coast Guard.

3.5.3.7.2 Divers are not required if the Coast Guard determines that conditions, such as diver visibility and/or safety, during the dive will render the divers inspection impractical and not beneficial to the Coast Guard. If divers will not be used in conditions that would typically require them; an alternate means of verifying block placement and contact shall be discussed in the docking calculations.

3.5.3.8 Hull and block contact inspection. Immediately after the vessel has been docked, the Contractor shall perform the following:

- Examine all blocks for total contact. Shim the blocks as necessary to provide total block contact with the vessel's hull.
- Install any supplemental blocking or shoring for the bow and/or stern overhanging structure as specified in docking plan.
- Refloat the vessel and take corrective action if any tendency to strain or damage the vessel is observed, or if the vessel is more than 6 inches off the center of the keel blocks. Concur with the COR before corrective measures are taken and before continuing with docking.

3.5.4 Within twenty four hours after docking. The Contractor shall begin the following:

3.5.4.1 Underwater body cleaning - removal of marine growth. The Contractor shall start cleaning the hull within four hours after the vessel has been docked, as specified below, to facilitate marine growth removal. The Contractor shall complete the hull cleaning before marine growth hardens

3.5.4.2 Hull cleaning. Remove all marine growth and oxidized coatings from the entire underwater hull from the upper edge of the boot top down, including sea chest strainer plates, sea chest interiors, fairwaters, rope guards, rudder, shaft strut, sea chest, z-drive, and thruster tunnel, and zinc anodes, as applicable by water-jetting to a WJ-4 visual surface condition, in accordance with SSPC-SP WJ-4/NACE

WJ-4. Cleaning shall be supplemented with stiff bristle brushes and scrapers as necessary, to remove all visible marine growth, loose rust, loose mill scale, and loose coatings. Do not use chemical additives in the freshwater wash or scrapers on bearing surfaces or transducer faces. Take extreme care to avoid damaging or removing existing intact underwater body coating.

3.5.4.3 Protective measures. As soon as practicable after dry-docking, underwater body surface cleaning, and in conjunction with work package items that involve the appendage, the Contractor shall do the following:

- Install protective covering over transducers, zinc anodes, propeller blade seals, rudder bearings, stern tube and strut bearings, spool pieces, spud wells, fin stabilizer seals and bow thrusters, as applicable.

NOTE

Transducer cover plate(s) may be provided as GFP – see Section 1.2 (Government-furnished property) of the work item in the specification package.

- Wrap bearings and seals, and insert soft caulking material into the open ends of rudder and shaft stave bearings to prevent entry of foreign materials during surface preparation and painting procedures.
- Place drain channels in overboard discharges in use to direct discharges away from the hull. Provide and install wooden plugs or coverings in sea chest spool pieces and overboard discharges not in use to prevent entry of sandblast grit or paint.

CAUTION!

Do not remove protective covers during the dry dock period except to accomplish specific work items or for inspection.

3.5.4.4 Interferences. The Contractor shall identify interferences to the hull openings or appendages by the blocking and/or cribbing, e.g. the skeg plug location identified on the docking plan as 6 inches forward of the end of skeg, after docking it's found to be 18 inches forward and a block cap has landed on it. The Contractor shall submit a CFR, including red line markup of the docking plan detailing the interference. The COR will review CFR and provide guidance to the Contractor for any removal of blocking or caps that is required to complete production work.

3.5.5 During the dry dock period. The Contractor shall track the weight and moment changes to the vessel caused by relocating or removal of liquid loads and/or dead loads (dunnage). Submit a CFR.

3.5.6 Fleeting. As specified in the work package, the Contractor shall fleet the vessel to another position on the blocks. Pre-docking, docking day, pre-undocking and undocking day events specified in this standard shall be adhered to in conducting the fleeting evolution. This entails floating/undocking the vessel, changing caps on side/bilge blocks to fit hull in next sequential position, and then docking the vessel. In this case cofferdams may be required for any hull opening that is mid-repair at the time of fleeting. Special consideration shall be made for the watertight integrity checks during the undocking. Calculations for planned fleeting evolutions (undocking and re-docking) shall be submitted along with the initial docking calculations, prior to docking the vessel. If the fleeting evolution is not determined to be required until after docking is complete, the calculations shall be submitted at least three (3) business days before fleeting. The calculations shall be completed using an estimated loading condition for the vessel at time of fleeting and include the block details for the second blocking position. Should the vessel be fleeted missing any ship's equipment, including but not limited to small boats, deck machinery or main space machinery, shafts, propellers; the calculations for fleeting shall be revised to suit the existing load

conditions at the time of fleeting.

3.5.7 Pre-Undocking events.

3.5.7.1 Four (4) business days before undocking. The Contractor shall notify the vessel crew and the COR of the schedule for undocking, including undocking conference date and time, a minimum of four business days in advance of the undocking evolution.

3.5.7.2 Three (3) business days before undocking. The Contractor shall submit to the COR the undocking calculations, as required in Appendix A. The calculations shall include the effects of the weight and moment changes during the dry dock period, e.g. weight additions, removals or relocations as a result of ship's actions and/or the Contractor equipment and materials.

3.5.7.3 Twenty four hours before undocking. The Contractor shall convene the undocking conference. At the conference discuss all undocking items to the satisfaction of the COR.

3.5.7.4 Twelve hours before undocking. The Contractor shall submit to the COR a written report attesting that the following conditions have been met and the COR will verify these items prior to undocking:

- All transducers are uncovered.
- Zincs are uncovered and free of paint.
- Shaft rope guard and fairwaters are in place.
- All hull opening blanks and plugs are removed.
- All sea chest strainers are bolted in place and lock-wired or otherwise permanently secured, as in the condition before being disturbed.
- All sea valves and waster pieces are properly installed and seated in the closed position.
- All underwater body work has been completed and hull accesses are closed.
- Drydock is free of all debris and blasting material.

3.5.7.5 Undocking preparations. The Contractor shall provide personnel stationed for watertight integrity checks as the vessel undocks. Special attention shall be paid to the sea chests that were overhauled during the availability.

3.5.8 Undocking day events.

3.5.8.1 Undocking evolution. The Contractor shall safely undock the USCG vessel, during daylight hours, in one continuous evolution. Undocking outside of normal daylight hours shall be by special request, approved by the KO. The request for night un-dockings shall include documentation of adequate lighting and safety procedures, and justification for the need. The Contractor shall ensure the dry dock is free of all debris and blasting material. As the last extremity of the vessel crosses the sill or plane of the dry dock, the point of the dry dock closest to the navigable channel, the Contractor's Dockmaster shall return the responsibility for the safety of the vessel to the CO/OIC.

3.5.8.2 Undocking tasks. The Contractor shall perform the tasks specified in the following paragraphs for undocking the vessel:

- 3.5.3.2 (Modification of loads).
- 3.5.3.3 (Personnel onboard vessel).
- 3.5.3.4 (Assistance for safe docking of vessel).

SFLC STANDARD SPECIFICATION 8634

- 3.5.3.5 (Weather delay).
- 3.5.3.6 (Floating dry dock operational limits).

3.6 Documentation of dry-docking significant events. The Contractor shall submit the following information in a separate written report to the COR within 48 hours after undocking the vessel.

- The precise time that the vessel's first extremity crossed the dry dock boundary upon docking.
- The precise time that the vessel's last extremity crossed the dry dock boundary upon undocking.
- The forward and aft draft readings just before docking and immediately after undocking.
- Removal of the temporary closures when the threat to watertight integrity no longer exists.

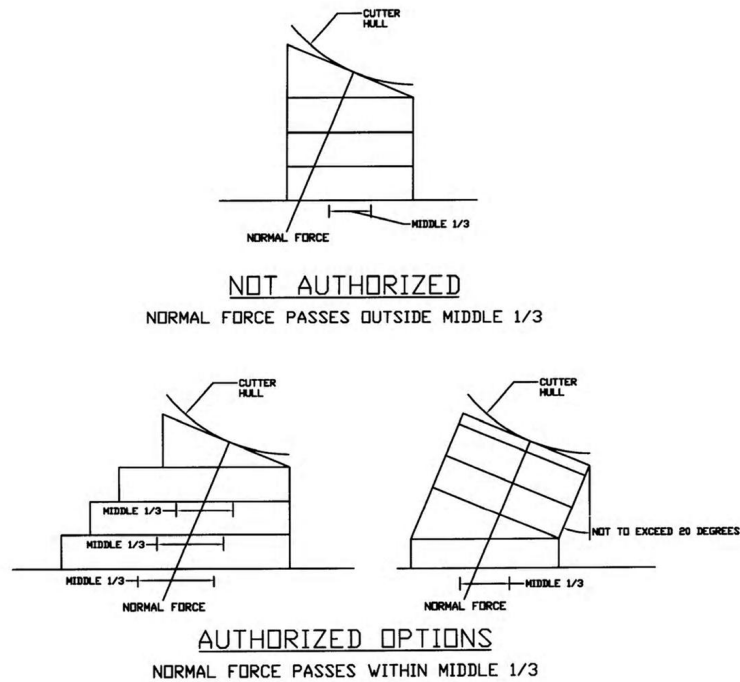

FIGURE 1. SIDE/BILGE BLOCK CONSTRUCTION

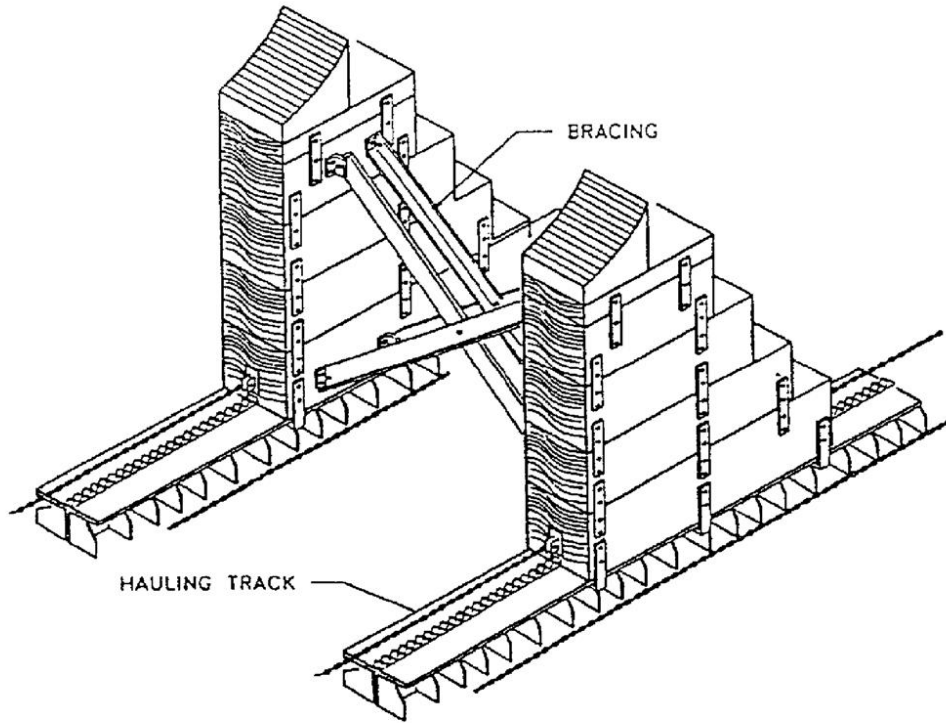

FIGURE 2. STIFFENED & BRACED SIDE/BILGE BLOCKS

APPENDIX A**REQUIREMENTS FOR CALCULATIONS****A1. SCOPE**

A1.1 Intent. This appendix describes particular requirements for the contractor to perform dry dock calculations.

A2. REQUIREMENTS

A2.1 General. The Contractor shall submit a minimum of three sets of dry dock calculations for review and approval: Pre-award, Docking and Undocking. Each set of calculations shall be prepared by a Naval Architect or a certified Dockmaster (see 3.3.1 Dockmaster) or under the supervision of a Professional Engineer.

A2.2 Calculations. The Contractor shall be aware that the stability calculations for the vessel and vessel/dock combined system, as applicable, shall include the KG, KM, and GM (stability index), in addition to drafts (estimated drafts for pre-award, actual arrival drafts for docking, and predicted drafts for undocking) and corresponding displacement values.

A2.3 Vessel's information. The KO will provide docking plan information/drawings, hydrostatic information and vessel Principal Characteristics in the specification work package. The Contractor shall submit a request to the KO for additional information necessary for performing dry dock calculations.

A2.4 Pre-award calculations. The Contractor shall submit to the KO a pre-award set of calculations, as listed in Table A1 (Drydocking Calculation Requirements) and specified below.

A2.4.1 Vessel hydrostatics. The calculations shall reflect the values given in the Routine Drydock work item provided in the work package as the Principle Characteristics of the vessel specified. The given displacement and Center of Gravity data shall be conservative, at vessel's Full Load values, and shall not be considered a prediction of the vessels arrival load condition.

A2.4.2 Pre-award calculations for class. The Contractor may have previously submitted pre-award calculations for a vessel of the same class that is scheduled to dry dock. In this case only, they shall be permitted to resubmit the class calculations as proof of capability for the current dry-docking availability. Exceptions to this case shall include when the vessel characteristics are significantly different from previously docked vessel and/or the certification capacity of the dry dock has been modified.

A2.5 Docking calculations. The Contractor shall submit a set of docking calculations to the KO for review and approval as listed in Table A1 and specified below. Calculations shall reflect the expected condition of the vessel when it enters the dry dock. The Facility shall ensure that work performed dock side that affects the stability condition prior to dry-docking is accounted for in the docking calculations. This includes but is not limited to antennae removal, contractor equipment on-loads, tank emptying, and/or anchor removal, which may be performed by the Contractor and/or the vessel's crew between the time of arrival and before dry-docking.

A2.6 Undocking calculations. The contractor shall submit a set of undocking calculations to the KO, or their representative, for review, as listed in Table A1 (Drydocking Calculation Requirements) and specified below, before undocking. The Facility shall ensure that work performed while in the dock which affects the stability condition prior to undocking is accounted for in the undocking calculations.

TABLE A1 - DRYDOCKING CALCULATION REQUIREMENTS

CALCULATIONS	Notes: P=Pre-award D=Docking U=Undocking	TYPE OF DRYDOCK FACILITY				
		Floating	Graving	Marine Railway	Vertical Lift	Crane/Travel Lift
Blocking Calculations (A2.7.1)	P, D, & U	X	X	X	X	X
Stability for vessel afloat	D & U	X	X	X	X	X
Draft at landing (A2.7.2.1)	D & U	X	X	X	X	
Stability at landing (A2.7.2.2)	D & U	X	X	X	X	
Draft at instability (A2.7.2.3)	D & U	X	X	X	X	
Vessel's draft when side blocks are hauled (A2.7.2.5)	D & U	X	X	X	X	
*System stability at Phase 3	P, D, & U	X				
*System stability at Phase 4	P, D, & U	X				
*System stability at Phase 5	P, D & U	X				
*Pumping plan (A2.8.2)	P, D & U	X				
Stabilizing Moment (A2.7.2.6)	D, & U			X	X	
Cable, Sling or Strap Tension (A2.7.2.7)	D & U				X	X

* Floating dry dock specifics can be found in paragraph A2.8

A2.7 Types of calculation.

A2.7.1 Blocking calculations. The Contractor shall provide the following:

A2.7.1.1 Trapezoidal (L Tons / ft). Trapezoidal loading along the keel line. This is distributed load bearing along the keel line and into the structure of the dry dock floor. Typically it is trapezoidal in nature due to the trim on the vessel. Generally the longitudinal center of gravity (LCG) of the vessel is aft of amidships, therefore the majority of load is applied aft. This trapezoidal loading is compared against the docking facility's maximum rated loading (LT/Ft) from the facility certification package.

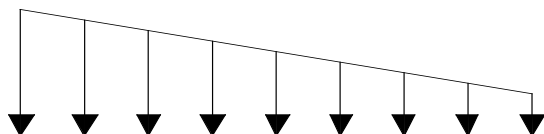

$$\text{Trapezoidal Load (LT/ft)} = \left(\frac{\Delta}{L_k} \right) \pm \left(\frac{6\Delta e}{L_k^2} \right)$$

where:

Δ = (LT) Vessel Displacement (From Curves of Form)

L_k – (ft) Length of supported keel (calculated)

e = eccentricity = distance from center of L_k to the vessel LCG (calculated)

(See Figure A2)

NOTE

For vessels utilizing a cradle, built per USCG Drawings, the only blocking calculations required are the trapezoidal loading per foot and knuckle loading.

A2.7.1.1.1 Trapezoidal (L Tons / ft) with cradle. For vessels utilizing a cradle, the distributed load bearing along the keel line and into the structure of the dry dock floor has two parts—the loading per foot experienced by the cradle for a given vessel's loading condition, and the weight of the cradle. The loading on the cradle is typically distributed along bilge blocks. In some cases, as with the 110 WPB, additional blocks are constructed after the vessel docks in the cradle. For the trapezoidal loading calculation for vessels using a cradle, the length of the supported keel shall be considered the length along the vessel that is supported by the cradle.

$$\text{Trapezoidal Load (LT/ft) with Cradle} = \left(\left(\frac{\Delta}{L_k} \right) \pm \left(\frac{6\Delta e}{L_k^2} \right) \right) + \left(\frac{W_c}{L_c} \right)$$

where:

Δ = (LT) Vessel Displacement (From Curves of Form)

L_k – (ft) Length of supported keel (calculated)

e = eccentricity = distance from center of L_k to the vessel LCG (calculated)

W_c = (LT) Weight of Cradle

L_c = (ft) Length of Cradle

A2.7.1.2 Knuckle load (L Tons). When docking a vessel that has trim or design drag (typically down by the stern), there is a knuckle load applied on the first keel block and an equal knuckle reaction (R_{kn}) created on the vessel as the keel touches at landing. This load is applied as a pivot point that rotates about the block at the point of touch down as the cutter lands on the blocks. This first block, which may be called the knuckle block (KB), will be at the extreme end of the keel line. Its location either Forward or Aft, depends on the trim of the vessel entering the dock. This load is typically seen on keel blocks, however, if no keel blocks are present then the knuckle load will be bearing on the first pair of side blocks. The knuckle load bearing on the keel block and subsequently through to the dock floor. This knuckle load increases as the buoyancy forces are taken off the vessel hull and as the vessel lands completely along the keel line. The knuckle load (LT) should be converted into a pressure based on the area of the contacting blocks to ensure the blocks are not compromised by this additional load, by comparing the knuckle pressure to the block timber stress limits.

$$\text{Knuckle Load Reaction, } R_{kn} \text{ (LT)} = \frac{MT1'' * \text{trim} * 12}{k * X_{kn}}$$

where:

MT1'' = (ft-LT) Moment to Trim 1'' (from Curves of Form or Hydrostatics)

trim = (ft) Trim between vessel keel and keel blocks (should include trim of dock and vessel drag)

k = overhang constant = 0.94 for large overhang or 0.97 for short overhang

X_{kn} = (ft) Calculated distance from outer edge of the first block to make contact with the vessel, the knuckle block (KB) to the vessel LCF (Value of LCF from Curves of Form or Hydrostatics).

Knuckle Load Pressure (psi) = R_{kn} / A_{KE}

Where:

A_{KB} = (in²) Area of knuckle block, the first block(s) to make contact with the hull

A2.7.1.3 Side Blocks. The number of side blocks required to meet seismic and hurricane overturning moments with dead loads included at 15% of total load.

$$M_S = (\Delta / g) * a * KG * 2240$$

where:

M_S = (ft-LT) Seismic Moment

Δ = (LT) Vessel Displacement (from Curves of Form)

g = Acceleration of gravity = 32.2 ft/sec²

a = 0.2 * g

KG = (ft) Vessel's afloat vertical center of gravity (from stability book, incline test, DC Book)

$$M_H = A_{Sail} * Sail_{Ht} * (0.004) * V^2$$

where:

M_H = (ft-LT) Hurricane Moment

A_{Sail} = (ft²) Sail are of vessel exposed to wind forces (calculated)

$Sail_{Ht}$ = (ft) Height of the Center of the Sail Area (calculated)

V = (knots) Velocity of wind Force (typically use 110 knots)

If $M_H > M_S$, use M_H ; If $M_S > M_H$, use M_S .

$$N_2 = M_{H/S} / (A_S * S_P * L_2)$$

Where:

N_2 = Number of side blocks required to resist seismic or hurricane forces

A_S = (in²) effective contact area for one side block (calculated)

S_P = (psi) Strength proportional limit of cap timber (typically 800 psi)

L_2 = (ft) Average half breadth of side blocks (from Docking Plan or Block Arrangement)

$$N_1 = [(N_2 * A_S) + (DL * 2240 / S_P)] / A_S$$

Where

N_1 = Number of side blocks on one side

DL = (LT) Dead Load on one set of side blocks = $\Delta * 0.075$

$N_S = N_1 * 2$ = Total Number of side blocks required to support the entire ship's dead load plus seismic or hurricane overturning forces

SFLC STANDARD SPECIFICATION 8634

A2.7.1.4 **Bearing area.** Total bearing area (side blocks + keel blocks) on hull and total distributed load throughout blocking build (psi). This bearing area shall consider the effective contact area of each block (e.g. if a 24 inch by 24 inch keel block is being used under a vessel with a 6 inch wide keel; the effective area is only 6 inches x 24 inches, not the entire upper surface of the block).

Bearing Area (in²) = (N_K * A_K) + (N_S * A_S)

where:

NK = Total number of Keel Blocks (from docking plan)

AK = (in²) Effective contact area for one keel block (from docking plan)

NS = Total number of side blocks (calculated above, or actual number from docking plan)

AS = (in²) Effective contact area for one side block (from docking plan)

Distributed Load = 2240 * Δ / Bearing Area

where:

Δ = (LT) Vessel Displacement (from Curves of Form)

Bearing Area = (in²) Total bearing Area (calculated)

A2.7.1.5 **Timber stress.** The Contractor shall provide the safe allowable block timber stresses. The permissible compressive stress, listed below, shall be used when considering side and keel block bearing loads applied to the blocking. The proportional limit loads are to be used when calculating the block stress due to overturning moments.

TABLE A2- WOOD PROPERTIES

WOOD PROPERTIES			
Block Material	Permissible Compressive Stress Perpendicular to the grain (psi)	Permissible Compressive Stress Parallel to the grain (psi)	Proportional limit Perpendicular to the grain (psi)
SOFTWOOD			
Douglas Fir	400	1400	800
Yellow Pine	300	900	700
HARDWOOD			
Red & White Oak	600	1300	1300

A2.7.1.6 Additional blocks. As needed, the Contractor shall propose additional keel and/or side blocks, to support underwater hull work ensuring that timber block permissible stress is not exceeded. Be aware that additional blocking is an alternate blocking arrangement.

A2.7.1.7 Alternate blocking arrangement. The Contractor shall submit an alternate blocking arrangement for approval to the COR when the vessel's docking plan does not match the dry dock structural limitations or when the keel/bilge blocks are considered interferences to scheduled work. The Contractor shall ensure that final block positions are adequately supported from both dock and ship structures. Calculation requirements shall be met using the alternate blocking arrangement. The alternate blocking plan must show sufficient detail to build and place the blocks, similar to the standard blocking arrangement. Plans must include the following details: block dimensions (length, width, and vertical height offsets to each corner and intermediate point); block locations and/or spacing from a known and measurable baseline (for example: vessel centerline and stern reference point); block materials and construction details; location of hull penetrations, appendages or other obstructions that must be avoided when blocking; and special notes for block construction including required bracing or wedging.

NOTE

A safe overhang is considered to be 1.5 to 2 times the molded depth of the vessel at the forward or aft most keel block for the bow or stern, respectively.

A2.7.2 Stability during docking/undocking.

A2.7.2.1 Draft at landing. The draft at landing, for a vessel with trim (typically down by the stern), shall be calculated to ensure the bow has fully landed prior to slacking mooring lines and hauling side blocks. As the force exerted by the keel block at the knuckle point takes on the weight (displacement) of the vessel and the buoyancy forces are reduced, the waterline along the length of the vessel's hull will recede as if it has fully landed, this is prior to the bow actually landing. This reaction can create a "false landing" effect and if acted upon, by slacking the handling lines and/or hauling side blocks too early, can cause the blocks to be positioned incorrectly on the hull.

$$D_i = D_m - [R_{kn} / (12 * TPI)]$$

Where:

D_i = (ft) Draft at Landing

D_m = (ft) Mean draft of vessel at docking

R_{kn} = (LT) Knuckle Reaction (calculated)

TPI = (LT/in)Tons per inch immersion (from Curves of Form or Hydrostatics)

A2.7.2.2 Stability at landing. Stability at landing shall be calculated to ensure the vessel maintains adequate stability during the docking evolution. At landing the effect of the force from the keel blocks on the vessel is essentially the same as reducing the weight of the vessel at the keel level. This effectively reduces the vessel's GM (stability index) during the landing.

$$GM_{\text{corr}} = KM - [(\Delta * KG) / (\Delta - R_{\text{kn}})]$$

Where:

GM_{corr} = (ft) Corrected transverse metacentric height (stability index) at landing

KM = (ft) Vessel's afloat metacentric height above the keel at mean draft (from Curves of Form)

Δ = (LT) Vessel Displacement (from Curves of Form)

KG = (ft) Vessel's afloat vertical center of gravity (from Stability book, incline test, or DC Book)

R_{kn} = (LT) Knuckle Reaction (calculated)

A2.7.2.3 Draft at instability. The draft at instability for the vessel shall be included in the calculations. After the vessel's keel has landed, the waterline on the hull continues to recede. As the weight of the vessel continues to increase on the keel blocks and buoyancy forces reduce, the effective GM (stability index) continues to decrease. At the draft at instability the vessel's virtual GM is equal to zero (0) feet. The vessel may take on an appreciable angle of list at this draft.

To calculate the draft at instability, hydrostatic data from several drafts both greater and less than the mean draft shall be required. Start with the mean draft of the vessel afloat, then use a draft of one foot above through 2 ft below the mean draft, e.g. $D_m = 5$ ft, use data points for drafts at 6 ft, 5 ft, 4 ft, and 3 ft. Using the Curves of Form collect data points for LCF, MT1, Displacement, and KM.

Next determine X_{kn} , the distance from edge of Knuckle Block (KB) to the LCF, for each of the drafts (See Figure A2).

Then determine R_{kn} , the knuckle reaction, as calculated above, for each of the drafts.

Next determine the moment of residual buoyancy for each of the drafts using the equation below;

$$M_{\text{RB}} = (D - R_{\text{kn}}) * KM$$

Where:

M_{RB} = (ft-LT) Moment of residual buoyancy at each draft

Δ = (LT) Vessel Displacement (from Curves of Form)

R_{kn} = (LT) Knuckle Reaction (calculated)

KM = (ft) Metacentric height at each draft (from Curves of Form)

Now, plot the M_{RB} (x - axis) versus Draft (y - axis) and a linear best fit line through all data points.

Then determine M_{GZ} , the vessel's afloat righting moment, a single point, using the equation below;

$$M_{\text{GZ}} = \Delta * KG$$

Where:

M_{GZ} = (ft-LT) Righting Moment

Δ = (LT) Vessel's afloat Displacement at time of docking (from Curves of Form)

KG = (ft) Vessel's afloat vertical center of gravity (from Stability book, Incline test, or DC Book)

Now, plot the point for the resultant M_{GZ} , using the M_{RB} scale on the x - axis. Then draw a line over to the corresponding draft on the y - axis for the draft at instability. Below is an example of the graph.

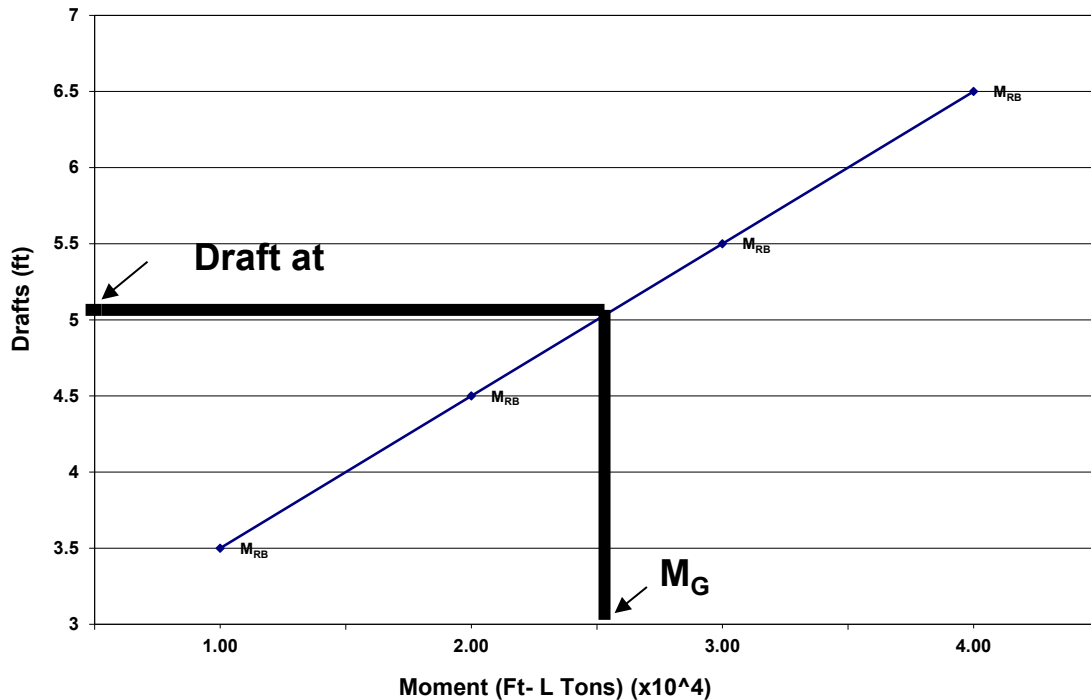
Moment vs. Draft (EXAMPLE)

A2.7.2.4 Safety consideration for draft at landing. The Contractor shall calculate draft at landing to ensure it is no less than one (1) foot above the calculated draft at instability. In cases where this requirement may not be met, whether due to damage to the hull, emergency docking, etc., precautions for line handling and hauling blocks shall be put into the docking procedure to ensure that the vessel's stability is maintained during the evolution. The precautions shall be discussed at the predocking conference and approved by the KO.

A2.7.2.5 Side/Bilge block hauling. When using hauled side blocks, the Contractor shall ensure the hauling occurs after the keel is fully landed and while the vessel's GM is a minimum of one (1) foot. The vessel's draft at the time of hauling blocks shall be at least 6 inches above the calculated draft at instability, so that there is full contact between all block caps and the hull well in advance of the draft at instability.

A2.7.2.6 Stabilizing moment. For marine railways, building ways and vertical lifts, the Contractor shall submit additional calculations for both overturning and stabilizing moments. The Contractor shall demonstrate that the stabilizing moment is at least 25% greater than the overturning moment, including wind and current forces.

A2.7.2.6.1 In-Water overturning: When the vessel is moored to a movable cradle; the stabilizing moment due to the cradle shall exceed the overturning force of the vessel prior to mooring (See Figure A3 for illustration). Calculation shall include both the wind and current forces. If the vessel is lifted by a cradle; but the vessel is moored to a fixed pier or other structure; this calculation is not required.

Overturning Moment on Cradle (In - Water)

$$M_o = [h * (F + P)] / 2240$$

where :

M_o = (ft - L Tons) Overturning Moment

h = (ft) Height of breast lines above the top of the track

F = (lbs) Force of the wind = $0.004 * V^2 * A$

where :

V = (knots) Velocity of the wind forecast for docking

A = (ft²) Sail area of the vessel

P = (lbs) Force of the current = $2.835 * V^2 * A$

where :

V = (knots) Velocity of the current forecast for docking

A = (ft²) Underwater area of the vessel being pushed by current

Stabalizing Moment of cradle (In - Water)

$$M_{stab} = \left(\frac{(W / 2240) * b}{2} \right)$$

where :

M_{stab} = (ft - L Tons) Stabalizing Moment

W = (lbs) Weight of the cradle

b = (ft) Width of the track

$$M_{stab} > 1.25 * M_o$$

A2.7.2.6.2 Out-Of-Water overturning: Once the vessel is lifted and if the vessel is blocked on a moveable cradle, the stabilizing moment due to the cradle shall exceed the overturning force of the wind.

Overtuning Moment on Cradle (Out - of - Water)

$$M_o = [h * (F + P)] / 2240$$

where :

$$M_o = A_{Sail} * h_{Sail} * (0.004) * V^2$$

where :

M_o = (ft - lbs) Wind Overtuning moment

A_{Sail} = (sqft) Sail area of the vessel and Blocking exposed to the wind forces (calculated)

h_{Sail} = (ft) Height of the center of the sail area above ground level (calculated)

V = (knot) Velocity of the wind force (typically use 110 knots)

Stabalizing Moment of cradle (Out - of - Water)

$$M_{stab} = \left(\frac{(W / 2240) * b}{2} \right)$$

where :

M_{stab} = (ft - L Tons) Stabilizing Moment

W = (lbs) Weight of the cradle and lifted vessel

b = (ft) Width of the cradle tracks/wheels

$$M_{stab} > 1.25 * M_o$$

A2.7.2.7 Hoisting loads. For vertical lifts and cranes that do not have load monitoring devices, the Contractor shall calculate the load on each strap or lifting cable. All strap loads shall be within 20% of each other. The weight distribution of the vessel shall be considered for the lift. The lifting slings/straps shall be placed symmetrically about the vessel's LCG. When lifting the vessel and buoyancy forces are off the hull, the weight of the vessel shall be as equally distributed as practicable between the forward and aft slings/straps.

A2.8 Floating dry dock.

A2.8.1 Floating dry dock stability. The Contractor shall demonstrate that the ship-dock system complies with the minimum GM requirements for the Ship/Dock system through all portions of the planned lift:

- Less than 10,000 LT Minimum GM of 5.0 feet
- 10,000 to 15,000 LT minimum GM of 4.8 feet.
- 15,000 to 20,000 LT minimum GM of 4.5 feet.
- 20,000 to 25,000 LT minimum GM of 4.3 feet.
- 25,000 to 30,000 LT minimum GM of 4.1 feet.
- 30,000 to 35,000 LT minimum GM of 3.9 feet.
- 35,000 to 40,000 LT minimum GM of 3.7 feet.
- 40,000 to 45,000 LT minimum GM of 3.4 feet
- Greater than 50,000 LT minimum GM of 3.28 feet.

A2.8.2 Preparation of a pumping plan. The Contractor shall create and submit a pumping plan as a prerequisite for docking a Coast Guard vessel in a floating dock. The pumping plan shall be developed for, at minimum, all five stages shown in Figure A1.

A2.8.2.1 Proper pumping plans. The Contractor shall submit to the COR a plan detailing the dry dock tank levels for each phase of required stability calculations. Each tank is dewatered in proportion to the load distributed above the tank. Pressing up or emptying dock ballast tanks non-proportionally to obtain adequate GM, by minimizing free surface effect, is not acceptable.

A2.8.2.2 Objective: The contractor shall prepare a pumping plan to satisfy the following objectives using Figures A1, A2, and A3:

- The dock shall have the required lifting capacity to lift the vessel in its desired longitudinal position with respect to the dock, taking into account the residual silt and water in the tank.
- During the docking evolution, the vessel by itself nor the vessel dock combination shall not become unstable.
- Structural integrity of the dock shall be maintained during the dry-docking evolution.
- Longitudinal bending moment and the deflection shall remain within the acceptable range.
- In case of multi-section docks, the connections shall not be overstressed.
- Bulkheads forming the tank boundaries shall not be overstressed because of excessive differential loading.
- Blocking shall not be overloaded, with special consideration at the knuckle block load.

A2.8.2.3 Plan content: In order to satisfy these objectives, the pumping plan shall define:

- The tank water levels after completion of dry-docking.
- Water levels in the tanks at intermediate drafts of the dry dock at which vessel stability status shall be checked.
- Observation to be made in the vessel at intermediate drafts.
- Deflection gauge readings and draft boards to be checked at the intermediate drafts.
- Tank water levels and dock drafts shall represent with the values that will be observed at the time of docking; for example: tank sounding depths instead of % full or water volumes.

A2.8.2.4 Planning: The contractor shall follow these steps in preparation of a pumping plan:

- Examination of vessel data, including its docking drawing, curves of form and inclining experiment or stability report.
- Examination of the vessel survey provided by the COR or vessel CO/OIC, including information on variable loads, vessel's drafts, and abnormalities (such as heavy lifts, trim, or hull damage).
- Calculation of the vessel's displacement and LCG at the time of docking, using arrival draft readings. Calculation of required changes to the variable loads onboard the vessel to correct for list, trim, and excessive free surface effects. Calculations shall include stability considerations described above.
- Dock survey, to determine effects of accumulated silt in tanks on available lifting capacity.
- Examination of the required blocking arrangement, to determine the longitudinal location of the vessel with respect to the dock and its center of gravity above the pontoon deck and structural supports.

A2.8.2.5 Distribution of lifting capacity (pumping plan). If strength and stability requirements are not violated, the amount of water that the Contractor shall remove from each tank may be calculated in advance. Be aware that a calculated pumping plan is for guidance only. The Dockmaster shall monitor the dock deflection and drafts during the evolution to ensure that the limits are not exceeded and account for the critical phases of operation. For large or sectional dry docks or when docking a vessel with extremely high loading at one end, the Contractor shall consider bending moments between tanks or dock sections in preparing the pumping plan.

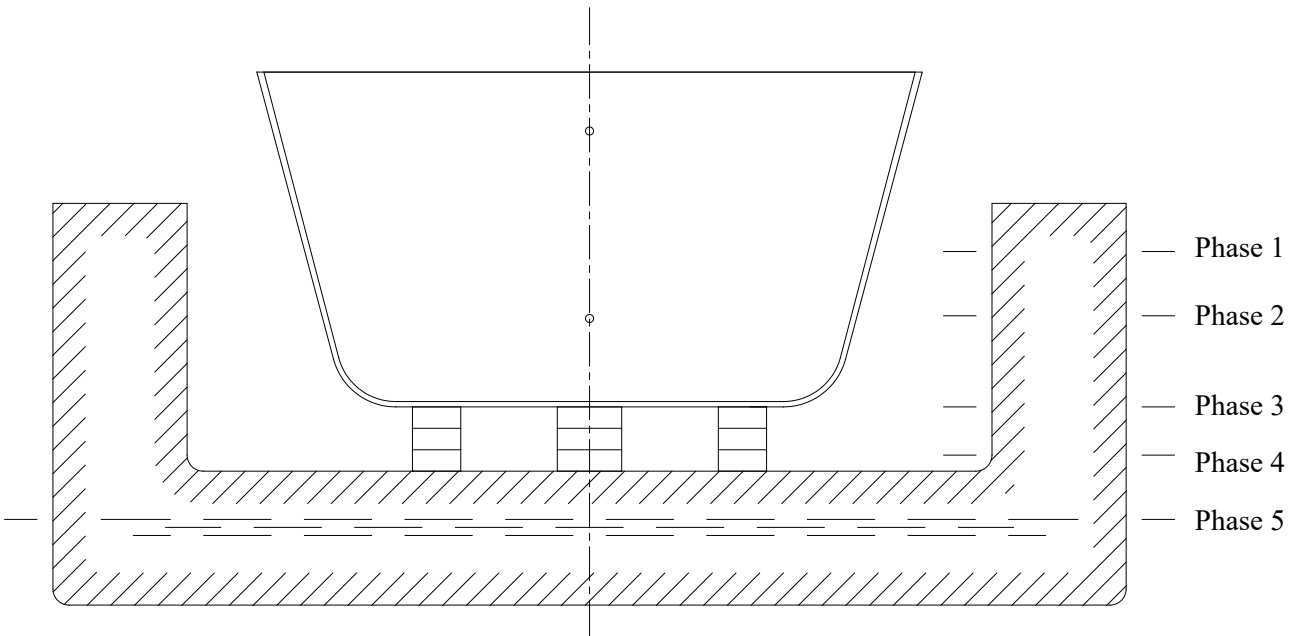

FIGURE A1. PHASES IN THE DOCKING EVOLUTION FOR STABILITY CALCULATIONS

Phase 1 – Fully ballasted down condition. In this phase the ship is floating independently and the dry dock is in the submerged condition before the ship bears on the blocks.

Phase 2 – Partial liftoff. This phase begins as the ship starts bearing on the blocks and part of the ships weight is supported by the floating dock.

Phase 3 – Ship keel at water level. This phase begins when the ship’s keel is about to leave the water plane.

Phase 4 – Top of pontoon at water level. This phase is when the water level between the wing walls is just above the top of the pontoon.

Phase 5 – Normal operating condition. Top of the pontoon is above the water level. Liquid Ballast is at a minimum.

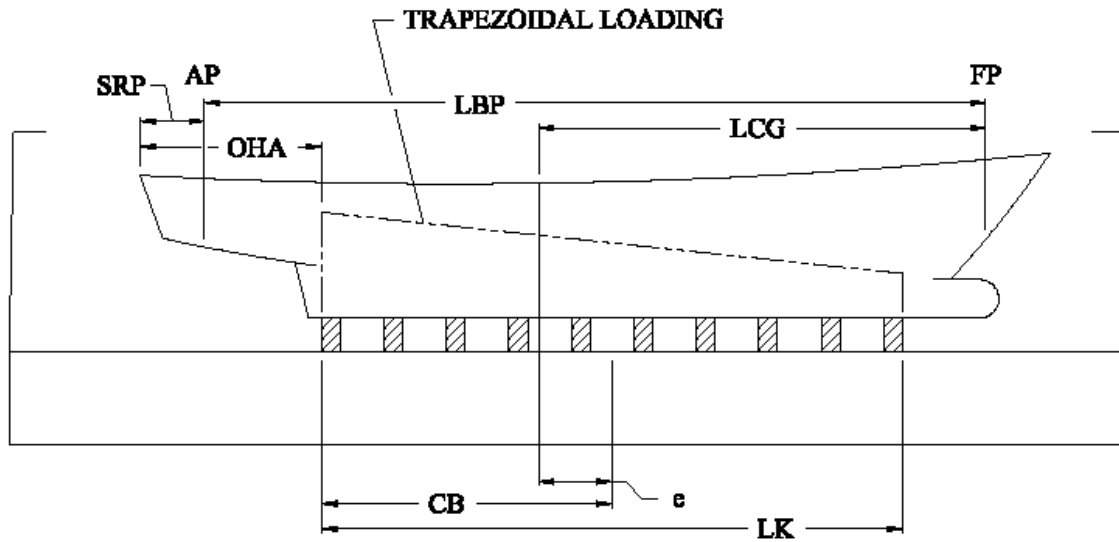

FIGURE A2. VESSEL KEY DIMENSIONS

- LBP** = Length Between Perpendiculars of ship
- SRP** = Distance from after perpendicular (AP) to the point from which distance to the keel blocks is referenced.
- LCG** = distance from forward perpendicular (FP) to ship's longitudinal center of gravity
- OHA** = length of overhang from SRP to first keel block
- LK** = Length of Keel Block
- Cb** = $Lk/2$ = Distance from the end of the keel blocking to the center of blocking.
- e** = $CB - (LBP - SRP - LCG - OHA)$ = Eccentricity (Distance from ship's LCG to the center of blocking).

NOTE

Note: e may be negative if LCG is FWD of center of blocking; this is acceptable and shifts the maximum trapezoidal load to the bow end of the block line.

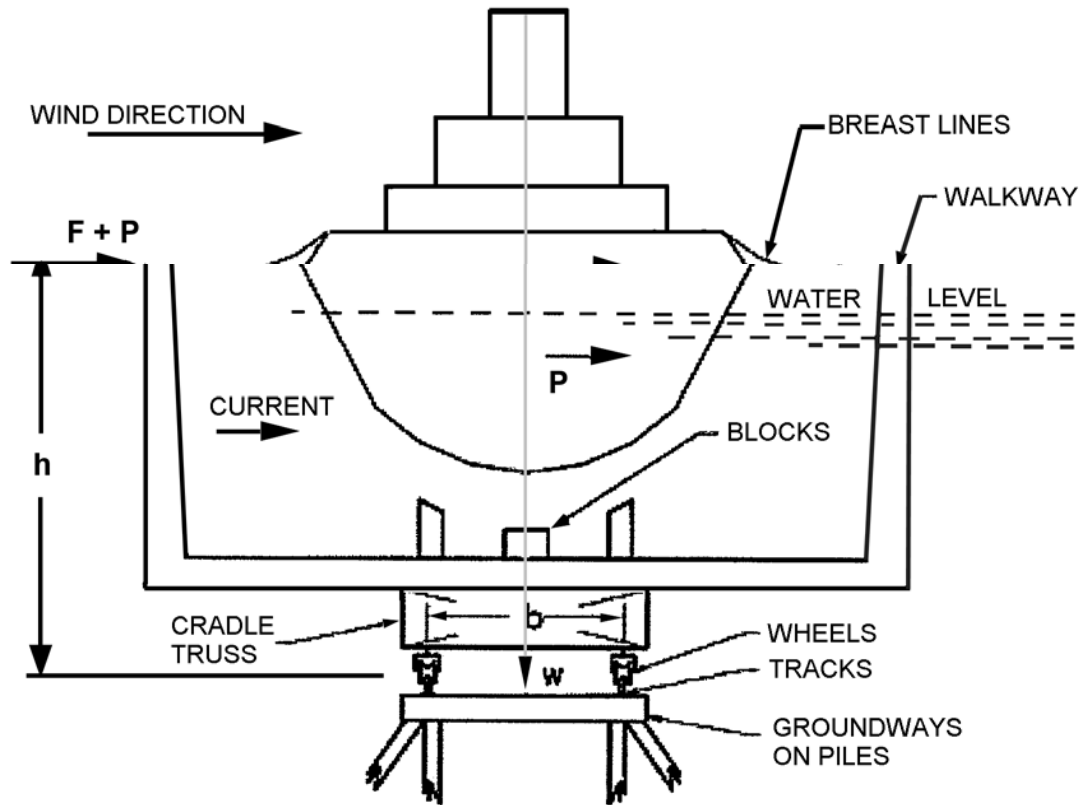

FIGURE A3. FORCES ON CRADLE DURING DOCKING ON MARINE RAILWAY/SYNCROLIIFT

- h** - Height of breast lines above top of tracks
- b** - Width of track
- W** - Weight of cradle
- F** - Wind load
- P** - Current load
- F + P** - Total load, assumed to be acting at the breast line

SFLC STANDARD SPECIFICATION 8634

FIGURE A4 - SAMPLE TABLE FOR WATER TO BE REMOVED FROM TANK FOR LIFTING A VESSEL

		①	②	③	④	⑤	⑥			
Tank	Bulkhead	Distance from 1 st Keel Block to Load Point (Note 2)	Slope of Load Curve	① * ②	Load / (L _A - ③)	Distance between load points in ④	Average load per tank: (L _A +L _F) / 2 (Note 3)	Weight per tank: ⑤ * ⑥	Specific volume of water (Note 4)	Gallons of water to be removed
8	First Keel Block									
7	8,7									
6	7,6									
5	6,5									
4	5,4									
3	4,3									
2	3,2									
1	2,1									
	Last keel Block									

Note 1: For shorter keel block lengths, the block may not extend across all tanks. In these cases the first keel block and last keel block are referenced over the tanks on which they are located.

Note 2: Load Points are the First Keel Block; Tank Bulkheads; and Last Keel Block.

Note 3: L_A = Aft load point over tank; and L_F = Forward load point over tank.

Note 4: Fresh Water = 269.3 gal/ton; Salt water = 261.8 gal/ton.

APPENDIX B

REQUIREMENTS FOR FACILITY INSPECTION

B1. SCOPE

B1.1 Intent. This appendix describes the particular requirements for a Contractor’s dry dock facility to be inspected by either an independent Professional Engineer.

B2. REQUIREMENTS

B2.1 General. The Contractor’s Professional Engineer shall use the checklist provided in this appendix, to conduct an independent survey of the Contractor’s dry dock facilities. The Contractor shall submit the completed and validated forms to KO.

B2.2 Validation for certification. The Contractor’s independent Professional Engineer shall witness an inspection and valid operational test of the Contractor’s facility and record conditions using within this Appendix. The Professional Engineer shall provide a signed/sealed statement to the Contractor attesting that the information within is valid, based on their professional judgment.

NOTE

The checklists provided with in this specification are formatted so that the Professional Engineer may obtain the necessary information for acceptance of the certification by USCG. The use of additional sheets, as necessary for informational purposes, is acceptable.

B2.3 Cycle for certification. Facility certifications will be considered valid for the duration stated below. Inspection cycles shall be based on the age of the facility; excepting cradles (see B2.3.1 (Cycle for cradle certification)). These periods shall be considered maximums; the certifying Professional Engineer may specify a shorter period if facility conditions warrant more frequent inspections.

AGE OF FACILITY	PERIODICITY
Less than 10 years	3 years
Over 10 years	2 years

B2.3.1 Cycle for cradle certification. The Contractor shall be aware that the period by which the completed docking/lifting cradle checklist shall be recorded as valid and accepted by USCG as certification shall be every four years.

B2.4 Applicability. The General Requirements inspection checklist sheets are required for all types of facilities, except in the case of cradles. The additional sheets are specific to the type of facility to be certified. Be aware that the each type of facility owned and operated by the Contractor shall have individual certifications.

INSPECTION CHECKLISTS FOR DRYDOCKING FACILITIES CERTIFICATION

The following is a list of the minimum facility requirements with integrated inspection checklists for each type of dry-docking facility. All required equipment or equipment that the Contractor intends to use shall be marked satisfactory at the time of the availability start date.

I hereby certify the material and operational conditions of the docking facilities identified as _____, owned and operated by _____, are safe for docking vessels within the facility's rated capacity on this the _____ day of _____, in the year of _____.

Date: _____

Registration State and No.: _____

Signature of Registered Professional Engineer: _____

SFLC STANDARD SPECIFICATION 8634

INSPECTION CHECKLIST FOR GENERAL REQUIREMENTS (ALL TYPES)

INSPECTED BY _____ **DATE** _____

FACILITY ID. _____ **SHEET NO.** ____ **OF** _____

ITEMS INSPECTED	CONDITION					REMARKS
	U	M	NA	NI	S	
Block Hauling Mechanism						(Mark all that apply)
Sheaves						
Tracks						
Chain/cable						
Pawls						
Structural members						
Ratchets						
Hauling winches/motors						
Slides						
Communication Systems						(Mark all that apply – Pass/Fail)
(One of the below is required)						
Public address system						
Radios						
Alarms						
Sound powered phones						
Dial telephone						
Bull Horn						

U-Unsatisfactory M-Marginal NA-Not applicable NI- Not inspected S-Satisfactory

NOTE: All marginal and unsatisfactory items shall be addressed in remarks. Attach additional sheets as necessary.

INSPECTION CHECKLIST FOR GENERAL REQUIREMENTS (ALL TYPES), CONTINUED

INSPECTED BY _____ DATE _____

FACILITY ID. _____ SHEET NO. _____ OF _____

ITEMS INSPECTED	CONDITION					REMARKS
	U	M	NA	NI	S	
Electrical Systems and Equipment						
Electrical power system shall support maximum load, developed by simultaneous operation of the dewatering pumps, fire protection pumps, valve opening and closing mechanisms, hauling machinery, communications equipment, lighting, alarms, and any other support equipment or systems necessary for the safe operation of the facility.						
Main power source (One of the below is required)						(Required)
Shore power						
Diesel gen. Set						
Back-up power source						(Optional)
Shore power						
Diesel gen. Sets						
Electrical power distribution						(Required)
Lighting for operations & security						(Required)
Ship grounding straps						(Required)
Welding machine grounds						(Required)
FIRE PROTECTION SYSTEM (One of the below is required)						(Required)
Installed fire protection system compliant with Occupational Safety and Health Administration (OSHA) regulations						
Memorandum of agreement with a local fire department ensuring that that fire department can arrive at the facility within 30 minutes of receiving the alarm.						

U-Unsatisfactory M-Marginal NA-Not applicable NI- Not inspected S-Satisfactory

NOTE: All marginal and unsatisfactory items shall be addressed in remarks. Attach additional sheets as necessary.

INSPECTION CHECKLIST FOR GENERAL REQUIREMENTS (ALL TYPES), CONTINUED

FACILITY ID. _____

SHEET NO. ____ **OF** ____

ITEMS INSPECTED	CONDITION					REMARKS
	U	M	NA	NI	S	
FITTINGS/CONNECTIONS						(Mark all that apply)
Cleats						
Bollards						
Chocks						
Gratings						
Ringbolts						
Platforms						
Watertight doors, hatches, portlights and manholes						
Gudgeon and pintle connections						
Bolted connections						
Attachments						
Reinforcements						
SHIP/DOCK HANDLING SYSTEMS AND EQUIPMENT						(Mark all that apply)
(One of the below is required)						
Capstans						
Winches						
Trolleys						
Translation chains and cables						
UNDERWATER INSPECTION Has there been an inspection performed within the last 5 years?						(Required)

U-Unsatisfactory M-Marginal NA-Not applicable NI- Not inspected S-Satisfactory

NOTE: All marginal and unsatisfactory items shall be addressed in remarks. Attach additional sheets as necessary.

INSPECTION CHECKLIST FOR FLOATING DRYDOCKS

INSPECTED BY _____ **DATE** _____

FACILITY ID. _____ **SHEET NO.** ____ **OF** _____

General Description. Attach a drawing of the dock showing general construction. Supply on the drawing, or in a table, all tank sizes, volumes and locations. Electronic geometry files showing the dry dock geometry, including tanks, are acceptable. Examples of acceptable files include but are not limited to: AutoCAD, GHS, SHCP or HECSALV models.

Age of Dock (yrs)	
LOA (ft)	
BOA (ft)	
Distance between wing walls (ft)	
Wing wall height (ft)	
Wing wall length (ft)	
Pontoon height (ft)	
Pontoon width (ft)	
The maximum water depth over the pontoon deck accounting for silt and tidal changes. (ft) The bottom dock shall maintain 12 inches clearance above the harbor bottom when fully submerged.	Max Depth over pontoon deck: Depth of harbor: Tidal Range:
Maximum wind and current under which docking and undocking can be safely conducted. Determined by Contractor's SOP.	Max Wind: Max Current:
Maximum rated capacity of the dry dock and the maximum load per foot.	Max Capacity (LT): Max LT/FT:
Maximum differential water levels permitted on tank bulkheads.	FT:
A current estimated weight & KG shall show the dry dock in the light operating condition with all ballast tanks at the residual water levels. A correction shall be added for deck load, marine growth and silt accumulation in the tanks.	Current WT (LT): Current KG:

INSPECTION CHECKLIST FOR FLOATING DRYDOCKS, CONTINUED

FACILITY ID. _____

SHEET NO. ____ OF ____

ITEMS INSPECTED	CONDITION					REMARKS
	U	M	NA	NI	S	
BALLASTING SYSTEM						(Required)
Do pumps operate?						(Pass/Fail)
Ballast and deballast in less than eight hours.						(Pass/Fail)
Do valves operate?						(Pass/Fail)
DEFLECTION DETECTION SYSTEM (Describe system if applicable)						(Optional)
DRAFT BOARDS Draft boards showing depth of water over pontoon deck at the wingwalls near the four inboard corners and at mid-length on the port and starboard sides.						(Required - Pass/Fail)
METHOD FOR DETERMINING TANK LEVELS						(Mark all that apply. One of the below is required)
Tank level indicators						
Sounding tubes						
HULL STRUCTURE Metal structural members shall have no more than 25% wastage. Wood structural members shall be free of wood rot, marine bores and deemed in good condition.						
Pontoon deck						
Pontoon sides/ends						
Pontoon bottom						
Wingwalls sides/ends						
Wingwall top deck						
Safety/machinery decks						
Interior Ballast/trim/ buoyancy tanks						

U-Unsatisfactory M-Marginal NA-Not applicable NI- Not inspected S-Satisfactory

Note: All marginal and unsatisfactory items shall be addressed in remarks. Attach additional sheets as necessary.

INSPECTION CHECKLIST FOR FLOATING DRYDOCKS, CONTINUED

FACILITY ID. _____

SHEET NO. ____ **OF** ____

ITEMS INSPECTED	CONDITION					REMARKS
	U	M	NA	NI	S	
HULL STRUCTURE (cont.)						
Trusses/girders/frames/ beams						
Longitudinals						
Swash bulkheads						
Watertight bulkheads						
Fuel/water tanks						
Coatings						
MOORING SYSTEM (dock to shore)						(Required)
Condition of mooring						
SECURE WT HANDLING EQUIPMENT						(If applicable)
The weight handling securing systems shall be demonstrated to verify that these systems are adequate to hold under conditions of maximum list and trim.						
STABILITY AND BUOYANCY CRITERIA						
Docking facility shall meet the following freeboard and buoyancy characteristics.						(Mark as applicable)
OPEN-ENDED DOCKS						
The minimum freeboard of the pontoon deck of the dry dock (excluding pits) with the rated maximum load lifted shall be 12 inches.						

U-Unsatisfactory M-Marginal NA-Not applicable NI- Not inspected S-Satisfactory

Note: All marginal and unsatisfactory items shall be addressed in remarks. Attach additional sheets as necessary.

INSPECTION CHECKLIST FOR FLOATING DRYDOCKS, CONTINUED

FACILITY ID. _____

SHEET NO. ____ **OF** ____

ITEMS INSPECTED	CONDITION					REMARKS
	U	M	NA	NI	S	
<p>CLOSE-ENDED DRY DOCK</p> <p>Minimum freeboard with the rated maximum load lifted shall be nine inches, measured from the sill of the stern (or bow) gates.</p>						
<p>FLOATING DRYDOCKS IN THE FULLY BALLASTED DOWN CONDITION</p> <p>During controlled ballasting of the dry dock, the minimum freeboard (measured from the top deck at side) shall be 12 inches.</p>						Required (Pass/Fail)
<p>EMERGENCY PUMPING PLAN</p> <p>The facility shall have an emergency plan or data demonstrating that failure of a pump or loss of pumping capacity will neither put the dry dock out of operation nor cause damage to either the dry dock or a ship in dry dock.</p>						Required (Pass/Fail)

U-Unsatisfactory M-Marginal NA-Not applicable NI- Not inspected S-Satisfactory

Note: All marginal and unsatisfactory items shall be addressed in remarks. Attach additional sheets as necessary.

INSPECTION CHECKLIST FOR GRAVING DRYDOCKS

INSPECTED BY _____ **DATE** _____

FACILITY ID. _____ **SHEET NO.** ____ **OF** _____

General Description: Attach a drawing or sketch of the dock showing general construction, arrangement, and facility layout of the dry dock with relationship to other major landmarks.

Age of Dock (yrs)	
Length of floor (ft)	
Width of dock opening (ft)	
Depth of dock (ft)	
The maximum water depth over the dry dock sill, while accounting for tidal ranges and silt accumulation.	Max Depth: Tidal Range:
Maximum wind and current under which docking and undocking can be safely conducted. Determined by Contractor's SOP.	Max Wind: Max Current:
Facility's rated capacity in total weight and LT/ft.	Max Capacity (LT): Max LT/FT:

U-Unsatisfactory M-Marginal NA-Not applicable NI- Not inspected S-Satisfactory

Note: All marginal and unsatisfactory items shall be addressed in remarks. Attach additional sheets as necessary.

INSPECTION CHECKLIST FOR GRAVING DRYDOCKS, CONTINUED

FACILITY ID. _____

SHEET NO. ____ OF ____

ITEMS INSPECTED	CONDITION					REMARKS
	U	M	NA	NI	S	
BALLASTING SYSTEM						(Required)
Do pumps operate?						(Pass/Fail)
Ballast and deballast in less than twelve hours.						(Pass/Fail)
Do valves operate?						(Pass/Fail)
STRUCTURES						
Inspect for significant cracks, leakage, spalling, inward/outward movement of vertical surfaces, upward or downward displacement of floor, and settlement of soil around dock.						(Mark all that apply)
Coping						
Walls						
Galleries						
Altars						
Service tunnels						
Floor						
Aprons						
Caisson seats						
Drainage culverts						
Drainage tunnels						
Flooding tunnels						
Discharge tunnels						
Pressure relief system						

U-Unsatisfactory M-Marginal NA-Not applicable NI- Not inspected S-Satisfactory

Note: All marginal and unsatisfactory items shall be addressed in remarks. Attach additional sheets as necessary.

INSPECTION CHECKLIST FOR GRAVING DRYDOCKS, CONTINUED

FACILITY ID. _____

SHEET NO. ____ **OF** ____

ITEMS INSPECTED	CONDITION					REMARKS
	U	M	NA	NI	S	
CAISSON						(Required)
Shell plating/Sheathing						
Structural framing						
Bulkheads						
Deck plating						
Top deck coverings						
Fenders						
Backing for seals						
Seals						
Fixed ballast						
DRAFT BOARDS Draft boards showing depth of water over dock floor near the four inboard corners and at mid-length on the port and starboard sides.						(Pass/Fail)
PUMP HOUSES General Condition						(Pass/Fail)

U-Unsatisfactory M-Marginal NA-Not applicable NI- Not inspected S-Satisfactory

NOTE: All marginal and unsatisfactory items shall be addressed in remarks. Attach additional sheets as necessary.

INSPECTION CHECKLIST FOR MARINE RAILWAY

INSPECTED BY _____ **DATE** _____

FACILITY ID. _____ **SHEET NO.** ____ **OF** _____

General Description: Attach a drawing or sketch of the dock showing general construction, arrangement, and facility layout of the dry dock with relationship to other major landmarks.

Age of dock (yrs)	
LOA of cradle (ft)	
Width between wingwalls of cradle (ft)	
Width between rails (ft)	
The maximum water depth over the cradle baseline, while accounting for silting and tidal ranges.	Max Depth: Tidal Range:
Maximum wind and current under which docking and undocking can be safely conducted. Determined by Contractor's SOP.	Max Wind: Max Current:
Facility's rated capacity in total weight and LT/ft.	Max Capacity (LT): Max LT/FT:

U-Unsatisfactory M-Marginal NA-Not applicable NI- Not inspected S-Satisfactory

NOTE: All marginal and unsatisfactory items shall be addressed in remarks. Attach additional sheets as necessary.

INSPECTION CHECKLIST FOR MARINE RAILWAYS, CONTINUED

FACILITY ID. _____

SHEET NO. ____ OF ____

ITEMS INSPECTED	CONDITION					REMARKS
	U	M	NA	NI	S	
CRADLES						(Required)
General conditions						
Decking						
Block bearers						
Elevated frameworks						
Under deck frameworks						
Drawhead girder						
Bottom chords						
Bitumastic enamel on steel						
Preservative on wood						
Wheel bearing supports						
DRAFT BOARDS Draft boards showing depth of water over cradle floor at the wingwalls near the four inboard corners and at mid-length on the port and starboard sides.						(Pass/Fail)
GROUNDWAYS & RAILS						(Required)
Inspect above water portion and splash zone						
Alignment of tracks						
Settlement of tracks						
Piles						
Stringers						
Cross bracing						
Track plates & fasteners						
Rail & fasteners						
Chain guides						

U-Unsatisfactory M-Marginal NA-Not applicable NI- Not inspected S-Satisfactory

NOTE: All marginal and unsatisfactory items shall be addressed in remarks. Attach additional sheets as necessary.

INSPECTION CHECKLIST FOR MARINE RAILWAYS, CONTINUED

FACILITY ID. _____ **SHEET NO.** ____ **OF** ____

ITEMS INSPECTED	CONDITION					REMARKS
	U	M	NA	NI	S	
GROUNDWAYS & RAILS (cont.)						(Required)
Mud & silt conditions						
Wheels						
Wheel bearings						
Rollers						
Roller spindles						
Roller frames						
Spacer blocks						
Wood filler pieces						
CHAINS, CABLES & SHEAVES						(Required)
Inspect for fit and percentage of wear						
Inhaul chains or cables						
Outhaul chains or cables						
Inhaul sheaves						
Outhaul sheaves						
Chain connecting links						
Sheave fasteners						
Chain slack & fit						
HAULING MACHINERY						(Required)
Inspect for lubrication, condition, fit and foundation						
Gearing						
Shafting						
Bearings						
Sprockets and wildcats						
Cable drums						
Frames						

U-Unsatisfactory M-Marginal NA-Not applicable NI- Not inspected S-Satisfactory

Note: All marginal and unsatisfactory items shall be addressed in remarks. Attach additional sheets as necessary.

INSPECTION CHECKLIST FOR MARINE RAILWAYS, CONTINUED

FACILITY ID. _____

SHEET NO. ____ OF ____

ITEMS INSPECTED	CONDITION					REMARKS
	U	M	NA	NI	S	
HAULING MACHINERY (cont.)						(Required)
Electric Brakes						
Hand brakes						
Locking pawls						
Clutches						
Safety guards						
Electric motors						
Diesels/gas engines						
Steam/compressed air drives						
Controllers						
Speed limit devices						
Control boards						
Switches						
Safety devices & alarms						

U-Unsatisfactory M-Marginal NA-Not applicable NI- Not inspected S-Satisfactory

NOTE: All marginal and unsatisfactory items shall be addressed in remarks. Attach additional sheets as necessary.

SFLC STANDARD SPECIFICATION 8634

INSPECTION CHECKLIST FOR VERTICAL LIFTS

INSPECTED BY _____ **DATE** _____

FACILITY ID. _____ **SHEET NO.** ____ **OF** _____

General Description. **Attach a drawing or sketch of the dock showing arrangement and facility layout of the dry dock in relationship to other major landmarks.**

Age of dock (yrs)	
LOA of platform (ft)	
BOA of platform (ft)	
Width between rails (ft)	
The maximum water depth over the lifting platform, while accounting for tidal ranges and silt accumulation.	Max Depth: Tidal Range:
Maximum wind and current under which docking and undocking can be safely conducted. Determined by Contractor's SOP.	Max Wind: Max Current:
Facility's rated capacity in total weight and LT/ft.	Max Capacity (LT): Max (LT/FT):

U-Unsatisfactory M-Marginal NA-Not applicable NI- Not inspected S-Satisfactory

NOTE: All marginal and unsatisfactory items shall be addressed in remarks. Attach additional sheets as necessary.

INSPECTION CHECKLIST FOR VERTICAL LIFTS, CONTINUED

FACILITY ID. _____

SHEET NO. ____ **OF** ____

ITEMS INSPECTED	CONDITION					REMARKS
	U	M	NA	NI	S	
HOIST						(Required)
Inspect for unusual running noises, lubrication, condition of wire rope, and foundations						
Motors						
Gears						
Brakes						
Wire ropes						More than 2 broken wires per wire rope requires replacement.
Bearings						
Drums						
Foundation platform						
Anchorage						
Piles						
Lubrication system						
Wiring						
PLATFORM						(Required)
Inspect for soundness of structure						
Main transverse beams						
Secondary transverse beams						
Longitudinal beams						
Stiffeners						
Decking						
Sheaves						
Bearings						
Sheave housings						
Tracks						
Pins Tracks						

U-Unsatisfactory M-Marginal NA-Not applicable NI- Not inspected S-Satisfactory

NOTE: All marginal and unsatisfactory items shall be addressed in remarks. Attach additional sheets as necessary.

INSPECTION CHECKLIST FOR VERTICAL LIFTS, CONTINUED

FACILITY ID. _____

SHEET NO. ____ **OF** ____

ITEMS INSPECTED	CONDITION					REMARKS
	U	M	NA	NI	S	
CRADLES						(Required)
Inspect for soundness of structure						
Main transverse beams						
Secondary transverse beams						
Stiffeners						
Longitudinal beams						
Wheels/rollers/roller plates						
Roller spindles/wheel axles						
Block bearers						
TRANSFER SYSTEM						(Required)
Inspect for unevenness in heights of tracks, excessive corrosion, hitching mechanism						
Tracks						
Hauling device						

U-Unsatisfactory M-Marginal NA-Not applicable NI- Not inspected S-Satisfactory

NOTE: All marginal and unsatisfactory items shall be addressed in remarks. Attach additional sheets as necessary.

INSPECTION CHECKLIST FOR TRAVEL LIFTS/CRANES

INSPECTED BY _____ **DATE** _____

FACILITY ID. _____ **SHEET NO.** ____ **OF** _____

General Description: Attach a drawing or sketch of the dock showing arrangement and facility layout of the dry dock in relationship to other major landmarks, including the lifting location and final blocking location.

Age of crane (yrs)	
LOA of travel lift (ft)	
Height from ground to cross bar (ft)	
Max allowable width of vessel (ft)	
Distance from ground to high water level (ft)	
Length of lifting cables (ft)	
Single or double upper cross tree	
The maximum draft, while accounting for tidal ranges and silt accumulation.	Max Draft: Tidal Range:
Maximum wind and current under which docking and undocking can be safely conducted. Determined by Contractor's SOP.	Max Wind: Max Current:
Travel Lift's overall rated capacity (including pier limitations) and strap capacity.	Max Capacity (LT): Strap Capacity (LT):

U-Unsatisfactory M-Marginal NA-Not applicable NI- Not inspected S-Satisfactory

NOTE: All marginal and unsatisfactory items shall be addressed in remarks. Attach additional sheets as necessary.

NOTE: Certified Rated Capacity should represent the capacity acceptable for USCG dockings (see Validation of operational test, Section 3.2.3.2.3).

INSPECTION CHECKLIST FOR TRAVEL LIFTS/CRANES, CONTINUED

FACILITY ID. _____

SHEET NO. ____ **OF** ____

ITEMS INSPECTED	CONDITION					REMARKS
	U	M	NA	NI	S	
DRIVE MECHANISM						(Required)
Inspect brakes, tires, wheels, bearing, emergency brake						
Hoist						(Required)
Transmission motor & Brake						
Emergency Brake						
Trolley & hoist block						
Transverse reducer and motor						
Wire						
Straps/Slings/Preventers						
Sheaves						
Drum						Minimum of two wraps on drum at lowest position
HYDRAULICS						(Required)
Hoses, fittings, tank, motor, valves, pump & fluid levels						
ENVIRONMENT						(Required)
Overhead clearance						
Road surface						
Final blocking surface						
STRUCTURE						(Required)
Top Beam, column platform, side beam						

U-Unsatisfactory M-Marginal NA-Not applicable NI- Not inspected S-Satisfactory

NOTE: All marginal and unsatisfactory items shall be addressed in remarks. Attach additional sheets as necessary.

INSPECTION CHECKLIST FOR TRAVEL LIFTS/CRANES, CONTINUED

FACILITY ID. _____

SHEET NO. ____ **OF** ____

ITEMS INSPECTED	CONDITION					REMARKS
	U	M	NA	NI	S	
PIER FACILITY						(Required)
Surface Condition						
Pilings						
Stops						
LOAD TEST						(Required)
Load applied:						
Date of Test:						
Rated Capacity:						

U-Unsatisfactory M-Marginal NA-Not applicable NI- Not inspected S-Satisfactory

NOTE: All marginal and unsatisfactory items shall be addressed in remarks. Attach additional sheets as necessary.

SFLC STANDARD SPECIFICATION 8634

INSPECTION CHECKLIST FOR DOCKING/LIFTING CRADLES

INSPECTED BY _____ **DATE** _____

FACILITY ID. _____ **SHEET NO.** ____ **OF** _____

General Description. Attach a drawing of cradle showing general construction if Coast Guard Drawing was not used as construction plan. Attach weld NDE test report.

Age of cradle (yrs)	
Coast Guard Drawing used for construction plan (if applicable, otherwise attach drawing)	
Type of cradle (if applicable, docking or lifting)	
Position cradle built in (if applicable, Pos. 1 or Pos. 2)	
LOA of cradle (ft)	
BOA of cradle (ft)	
Weight of cradle (LT)	
The maximum water depth over the cradle (from point of highest bilge block), while accounting for tidal ranges and silt accumulation.	Max Depth: Tidal Range:
Maximum wind and current under which docking and undocking can be safely conducted. Determined by Contractor's SOP.	Max Wind: Max Current:
Cradle's rated capacity in total weight and LT/ft.	Max Capacity (LT): Max Capacity (LT/ft):

U-Unsatisfactory M-Marginal NA-Not applicable NI- Not inspected S-Satisfactory

NOTE: All marginal and unsatisfactory items shall be addressed in remarks. Attach additional sheets as necessary.

INSPECTION CHECKLIST FOR DOCKING/LIFTING CRADLES, CONTINUED

FACILITY ID. _____ **SHEET NO.** ____ **OF** ____

ITEMS INSPECTED	CONDITION					REMARKS
	U	M	NA	NI	S	
STRUCTURE						(Required)
Inspect both cradle and spreader bar, as applicable						
General Condition						
Bilge Block Supports						
Vertical Guide Posts						
Weld Joints						(Attach NDE test report)
Bolt Joints						
Bolts						
Drain Plugs Removed and Inspect Bilge Block Supports						
Drain Plugs Removed and Inspect Spreader Bar and Sway Brace Interior						
Pad Eyes						
Centering Track Alignment Check						
Preservation on Steel Sections						
LOAD TEST						(Required)
Load applied:						
Date of Test:						
Rated Capacity:						

U-Unsatisfactory M-Marginal NA-Not applicable NI- Not inspected S-Satisfactory

NOTE: All marginal and unsatisfactory items shall be addressed in remarks. Attach additional sheets as necessary.

**INSPECTION CHECKLIST FOR BLOCK/CRADLE FOUNDATIONS
(THAT ARE SEPARATE FROM CERTIFIED DOCK FLOORS)**

INSPECTED BY _____ **DATE** _____

FACILITY ID. _____ **SHEET NO.** ____ **OF** _____

General Description. Attach a drawing of site showing general location, layout, and dimensions. Attach site survey, drainage plan, and geo-technical data.

Foundation composition description (i.e concrete, compacted gravel, asphalt, etc.)	
Grade elevation (ft)	
Maximum frost penetration depth (inches) (if applicable)	
Water table elevation (ft)	
Length of foundation site (ft)	
Width of foundation site (ft)	
Allowable bearing capacity (psf)	

U-Unsatisfactory M-Marginal NA-Not applicable NI- Not inspected S-Satisfactory

NOTE: All marginal and unsatisfactory items shall be addressed in remarks. Attach additional sheets as necessary.

APPENDIX C**REQUIREMENTS FOR DOCKING AND LIFTING CRADLES****C1. SCOPE**

C1.1 Intent. This appendix describes the requirements for construction and testing of docking and lifting cradles for patrol boats and small cutters.

C2. REQUIREMENTS

C2.1 Cradle option. If the Contractor chooses to dry dock the designated patrol boat on a cradle, the Contractor shall ensure the following:

C2.1.1 Docking cradle. The docking cradle shall be constructed, according to the applicable Coast Guard drawing indicated in Table C1. When compared to lifting cradles, docking cradles may have less supporting structure as they are supported by the dock floor. Drawings specified as docking cradles cannot be used for lifting application.

C2.1.2 Lifting cradle. The lifting cradle is similar to the docking cradle with additional pad eyes added to the structure to enable the cradle to be lifted with a crane or travel lift. The lifting cradle shall be constructed, according to the applicable Coast Guard Drawing as indicated in Table C1. Cradles listed as lifting cradles may be used for either docking or lifting. Docking cradles, however can be used for docking only- not for lifting.

C2.1.3 Portable cradles. If a cradle is designed to break into smaller pieces for transport of the cradle to another location, all structural mounting hardware shall be replaced at time of assembly. This applies to initial assembly and every future assembly; once the hardware is used for lifting and removed, it shall not be re-used. Hardware used for non-structural fastening (example: guide post mounting) may be re-used.

C2.1.4 Transport cradle. Cradles intended for ship deck, or similar transport, shall be reviewed and approved by the Technical Warrant Holder on a per-case basis due to the interface required between the cradle and the transport vessel. Drawings of the cradle to be used, principle characteristics of the transport vessel, and limiting environmental conditions during the transport, as well as the proposed arrangement on the transport vessel shall be provided at the time of review. Additional information may also be required on a per case basis.

TABLE C1. APPLICABLE COAST GUARD DRAWINGS

VESSEL CLASS	DOCKING CRADLES	LIFTING CRADLE
154 WPC	TBD	TBD
110 WPB	110 WPB 085-002 (Shts 5-8) 110 WPB 085-010 110 WPB 085-14	110 WPB 085-010 110 WPB 085-14
87 WPB	87 WPB 085-010 87 WPB 085-012	87 WPB 085-012

CAUTION!

Cradles for the 110 WPB built using Coast Guard Drawing 110 WPB 085-002 are classified as docking cradles only and cannot be used with crane or travel lift operations. Only cradles for the 110 WPB built using Coast Guard Drawing 110 WPB 085-010 can be used as either a docking or lifting cradle.

NOTE

After construction, the lifting or docking cradle shall be certified by a third party according to an approved method as indicated in Section 3.2 of this Standard Specification.

C2.1.5 Variation on cradle construction. If the Contractor constructs a docking or lifting cradle deviating from the design in the applicable Coast Guard Drawings, the Contractor shall submit construction and fabrication drawings for the cradle, as well as either hand or finite element analysis calculations analyzing the structure that verify the design for the cradle. These drawings and calculations shall be signed and sealed by a Professional Engineer. The drawings shall indicate any weld joints that require NDE to prove the welds have been installed correctly upon cradle fabrication. For lifting cradle designs, the submitted drawings shall define which rigging points shall be load tested, and show the loads to be used in the test. The Contractor shall submit cradle drawings and supporting calculations to the KO no later than seven days before the docking day for review.

C2.1.6 Variations in lifting arrangement. If the contractor intends to lift a cradle using an alternate lifting arrangement, including number of lifting devices, or sling configurations. The contractor shall submit construction and arrangement drawings for the lifting design as well as either hand or finite element analysis calculations analyzing the structure and lifting gear. These drawings and calculations shall be signed and sealed by a Professional Engineer. The drawings shall indicate all test requirements and load ratings. The contractor shall submit lifting arrangement drawings, supporting calculations and certification of the lifting devices to the KO no later than seven days before the docking day for review.

C2.2 Cradle testing.

C2.2.1 Verification of cradle construction. After completion of cradle fabrication and prior to proof testing, cradle key dimensions shall be verified against the design drawing. Cradle shall be straight, level, and free of any deformations that prevent the final block heights from falling within the required tolerances (section 3.5.2.2). Material conditions shall be documented for comparison post proof test.

C2.2.2 Proof testing of cradles. After completion of cradle fabrication and prior to docking/lifting the

vessel, a proof test of the cradle shall be completed, as outlined below, in the presence of the certifying agent

NOTE

The portion of the proof test involving weights shall only be performed for initial certification following original fabrication of cradles, or upon modifications to the original cradle. NDE testing of welds shall be performed at each certification interval (initial certification and re-certification).

C2.2.2.1 Docking cradle proof test. The Contractor shall simulate the trapezoidal loading condition (see A2.7.1.1 (Trapezoidal)) by distributing verified concrete weights along the cradle. The required proof test weights shall be distributed evenly from side to side. The cradle shall remain loaded for 1 hour before weights are removed. After weight removal, the cradle shall be thoroughly inspected for deformation of structure/joints and cracking in any welds. Following the weighted proof test, the Contractor shall perform NDE of the cradle structural welds, as designated by the certifying agent and those designated on construction drawing.

C2.2.2.2 Lifting cradle proof test. The Contractor shall proof test a lifting cradle by accomplishing the following:

- Using the lifting sling arrangement shown on applicable Coast Guard Drawing, lift the cradle with verified concrete weights positioned above or suspended below it, to simulate the loading conditions that will exist when lifting the vessel. The required proof test weights for the forward and aft portions of the cradle shall be distributed evenly from side to side, and the cradle shall be loaded according to Table C2.

TABLE C2. CRADLE DESIGN LOAD DISTRIBUTION

Vessel Class	LOAD FORWARD	LOAD AFT
154 WPC	TBD	TBD
110 WPB	49 Long Tons	77 Long Tons
87 WPB	55 Long Tons	55 Long Tons

- Raise and lower the cradle and testing weights at least three cycles; each cycle should include lowering to the point of slack lifting slings. Then hold the cradle and weights suspended for twenty minutes and ensure that there is no slippage of wire rope in wire rope sockets. Thoroughly inspect for deformation of any structure/joint, or cracking in any welds.
- Spreader Bars shall be tested as part of the cradle proof test. If a spreader bar is repaired and requires re-testing, a pull test against a fixture may be used in place of retesting the entire cradle assembly. The testing device shall be rated appropriately for the specific spreader bar and shall include load indicators to verify the loads applied.
- All rigging to be used with the cradle shall be tested as part of the proof test. Standard rigging hardware may be interchanged for the specific hardware used for proof testing provided it has an equal or higher safe working load. If custom rigging pieces require replacement, a pull test against a fixture may be used in place of retesting the entire cradle assembly. The testing device shall be rated appropriately for the specific spreader bar and shall include load indicators to verify the loads applied.
- After completion of load test, the facility shall perform NDE of the structural welds on the cradle and spreader bar as prescribed on the construction drawings and any welds designated by the certifying agent.

C2.2.2.3 The contractor shall submit a written test result for the completed proof and NDE tests to the KO, as part of the completed certification package.

C2.3 Cradle identification. After construction and proof testing all cradles shall be labeled permanently with a unique identification.

C2.3.1 Structural part identification. After construction and prior to proof testing each structural parts of cradles that can be disassembled shall be marked with the cradle's identifying serial number. This serial number shall be referenced in the certification documentation and for tracking the history of the cradle. All marking shall be welded or stamped.

C2.3.2 Proof test markings. After proof testing of the cradle, the proof test results shall be marked on the cradle indicating, at minimum, design drawing number, proof test weight, proof test date and safe working load. Information shall be marked on the cradle in one location. If no location is specified on the drawings the proof test load data shall be placed where visible when the cradle is assembled. All markings shall be permanently welded or stamped; it is acceptable to fabricate a sheet metal plate with the identifying information and tack-weld this plate to the cradle frame. Paint, stickers, or other markings that may be easily damaged are not acceptable.

C2.4 Deviation for 110 WPB cradle arrangement. If the Contractor wishes to propose a method other than the cradle arrangement specified herein for the 110 WPB, the Contractor shall, in conjunction with the bid submittal, submit a detailed plan including blocking arrangement details and calculations, as specified in Appendix A.

C2.4.1 110 Patrol Boats shall be docked using an approved cradle when available; however, blocking proposals may be approved on a case-by-case basis.

APPENDIX D

REMOVED

D1. SCOPE

D1. Removed – Reserved for Future Use.

D2. REQUIREMENTS

D2.1 None.

D.3 NOTES

D3.1 None.

APPENDIX E

CONFERENCE AND INSPECTION CHECKLISTS FOR PRE-DOCKING, DOCKING, AND UNDOCKING

E1. SCOPE

E1.1 Intent. This appendix describes the particular requirements of docking conferences and inspections that occur at various phases of the docking evolution. The facility operator and USCG on-site personnel should review and complete these checklists at the appropriate phase.

E2. REQUIREMENTS

E2.1 General. The USCG appointed inspector shall use the checklists provided in this appendix, to conduct both docking conferences and inspections.

E2.2 Conferences and inspection schedule. The USCG appointed inspector shall, along with the facility operator and boat/cutter personnel on-site, complete the included checklists for the following conference and inspection schedule:

- Pre-Docking conference checklist
- Pre-Docking dock inspection
- During & post docking inspection
- Pre-Undocking conference checklist
- Undocking inspection:

NOTE

The checklists provided within this specification appendix are formatted so that the USCG appointed inspector may obtain the necessary information for acceptance of the inspection by USCG. The use of additional sheets, as necessary for informational purposes, is acceptable.

E2.3 Applicability. The inspection checklist sheets are for use with the docking of all cutters and boats and applies to all facility types.

E3. NOTES

E3.1 None.

CHECKLIST E1: PRE-DOCKING CONFERENCE CHECKLIST

ITEM	SAT	UNSAT
DOCUMENTATION TO BE PROVIDED		
Current Dock Certification		
Operating practices, safety requirements, and yard security plans.		
Docking Calculations		
Blocking Arrangement (If different from docking plan)		
Docking Procedure		
FACILITY SAFETY EQUIPMENT		
Fire alarm locations		
Emergency power		
Emergency ballast/dewatering pumps		
REVIEW		
The flooding and pumping plan for the dry dock. (allowable trim and deflection)		
Specific list, trim and drafts of the vessel during docking. (Grounding, when blocks are hauled) Critical Draft -		
GM of ship dock system all phases(Floating DD only - Not less than 5' except on docks of greater than 10,000 LT capacity)		
Block Loading - Trapezoidal, Knuckle		
Any special precautions or actions characteristic to the docking facility, the docked vessel, or a combination.		
High/low water, currents, weather		
Communications plan		
Tug plan		
Cutter entry plan (Line handlers, fenders)		
Cutter clearance above keel blocks, side blocks and other potential obstructions		
Docking position		
Procedure for positioning cutter in dock		
When to secure ship's power		
Use of divers		
Arrange time for block inspection		
Time & Date of Drydocking		
CUTTER CONDITION		
Verify cutter load condition (tanks, drafts, displacement)		
All equipment retracted		
Verify Temporary Services/hookups		
Drafts:FWD _____, MID _____, AFT _____		

CHECKLIST E2: PRE-DOCKING DOCK INSPECTION

ITEM	SAT	UNSAT
FOUNDATION BLOCK - TIMBER		
Check timber for excessive crushing, warping, cracking, rot and degraded material		
Note amount of wear from spiking and dogging		
Evaluate the condition of the interfacing between blocks in the stack		
Note condition of the fasteners in the blocks		
Note arrangements for preventing tripping and floating of blocks		
FOUNDATION BLOCK - CONCRETE		
Structural damage due to over loads		
Corrosion of steel reinforcement		
Concrete for cracking, spalling and exposed rebar		
FOUNDATION BLOCK – STEEL		
Evaluate the loss of steel due to corrosion		
Look for cracks in welds		
Deformed structure		
BLOCKS – GENERAL		
Soft Caps min thickness 2 & no crush		
Spacing & location as per blocking arrangement (+/- 1/2 transversely +/- 1 longitudinally, +/- 1/4 height)		
KEEL BLOCKS		
Sight keel block line for alignment and fit		
Keel block height meets requirement		
Keel Profile applied to keel block offsets		
SIDE/BILGE BLOCKS		
Sight side/bilge block line for alignment and fit		
Side/bilge blocks are required dimensions		
Side/bilge block construction. (Normal force passes through middle 1/3 of all blocks, no gaps, cribbing if over 6')		
MISCELLANEOUS		
Crane clearance		
Check overhead interferences and clearances		
Depth of water (Tide dependent)		
Condition of the working floor for debris, unevenness etc.		
Note mooring system, possibility of streaming		
Note draft/trim devices in use		
Condition of fendering		
Condition of Lifting Straps		

CHECKLIST E3: DURING & POST DOCKING INSPECTION

ITEM	SAT	UNSAT
DURING DOCKING EVOLUTION		
Time & date bow crosses sill. _____ , _____		
Cutter came in smoothly. Could it have hit any underwater obstacles?		
Position of the cutter is correct.		
Correct draft of dock when cutter grounds		
Correct drafts of dock & cutter when cutter is landed		
Check for cutter list and alignment		
Correct draft of cutter when side/bilge blocks are hauled		
All side/bilge blocks were hauled fully		
Draft of cutter when setting down on pre-set side/bilge blocks		
Keel Centered on keel blocks		
Trim and docking plan being followed		
POST DOCKING EVOLUTION		
Proper Contact area (Wedges may be required) If inadequate area refloat (Less than 80%)		
Drafts of dock		
(FWD _____ , MID _____ , AFT _____)		
Does dock have a hog or sag?		
Are any blocks hitting appendages?		
Any appendages not shown on docking plan or in wrong location?		
Excessive crush of blocks?		
Location:		
Verify correct position of cutter on blocks		
Ensure side haul blocks are locked in position		
Damage to cutter (describe below)		

CHECKLIST E4: PRE-UNDOCKING CONFERENCE CHECKLIST

ITEM	SAT	UNSAT
DOCUMENTATION TO BE PROVIDED		
Recorded Weight Shifts during availability		
Undocking Calculations		
Undocking Procedure		
UNDOCKING REPORT		
Transducers uncovered		
Zincs uncovered and free of paint		
Shaft rope guard & fairwaters in place		
Hull opening blanks & plugs removed		
Sea chest strainers are bolted in place and lockwired		
Sea valves & waster pieces are properly installed and are in the closed position		
All underwater body work has been completed		
Dock is free of all debris and blasting material		
REVIEW		
The flooding and pumping plan for the dry dock. (allowable trim and deflection)		
Specific list, trim and drafts of the vessel during undocking. (when side blocks are hauled)		
GM of ship dock system all phases(Floating DD only - Not less than 5' except on docks of greater than 10,000 LT capacity)		
High/low water, currents, weather		
Communications plan		
Tug plan		
Temporary services disconnection		
Cutter exit plan (Line handlers, fenders)		
Cutter clearance above keel blocks, side blocks and other potential obstructions		
Pier Location & Temporary services hookup		
Where personnel will be stationed (All hull openings that were worked on)		
Procedure if immediate re-docking is required		
Is ballast required for undocking?		
Time & Date of Undocking _____,		
CUTTER CONDITION		
Verify cutter load condition (tanks, drafts, displacement) Perform Tank sounding within 12 hours of undocking.		

SFLC STANDARD SPECIFICATION 8634

CHECKLIST E5: UNDOCKING INSPECTION

ITEM	SAT	UNSAT
DURING UNDOCKING EVOLUTION		
All equipment retracted		
Verify Temporary Services/disconnection		
Personnel at hull openings		
Stopped at correct draft for hauling side blocks		
Hauled ALL side blocks FULLY		
Detection of any leaks		
Cutter exited smoothly. Could it have hit any underwater obstacles?		
Time & date bow crosses sill _____,		
Drafts: FWD _____, MID _____, AFT _____		
Damage: (describe below)		
<div style="border: 1px solid black; height: 150px; width: 100%;"></div>		